

Scheren

Scissors



Gefäßscheren

Artery scissors

Ciseaux vasculaires

Tijeras vasculares

Forbici vascolari



1:2

145 mm – 5¾"	308-464-150
--------------	-------------

- 1 Blatt mit Sondenspitze
- 1 Blade with probe
- 1 Lame avec sonde
- 1 Punta forma sonda
- 1 Lama con sonda



1:2

LINCOLN	1:2	170 mm – 6¾"	03-516-170	03-517-170
----------------	-----	--------------	------------	------------

1:2

1:2



1:2

115 mm – 4½"	03-508-115
--------------	------------



1:2

FULTON	1:2	170 mm – 6¾"	03-519-170
---------------	-----	--------------	------------



1:2

POTTS-SMITH (DE MARTEL)	1:2	195 mm – 7¾"	03-521-045
------------------------------------	-----	--------------	------------

Gefäßscheren

Artery scissors

Ciseaux vasculaires

Tijeras vasculares

Forbici vascolari

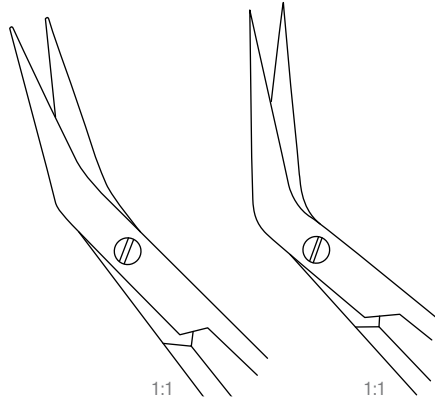

FAVALORO

150 mm – 6"

411-415-900



DE BAKEY

155 mm – 6"

03-551-155

03-553-155

Offset-Schere, S-förmig

Offset scissors, s-shaped

Ciseaux offset, courbes en S

Tijera offset, curva en S

Forbici offset, curve a forma di S



MILLS

225 mm – 8¾"

308-471-220

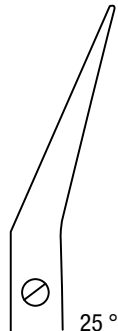

25°

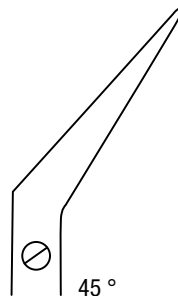

45°

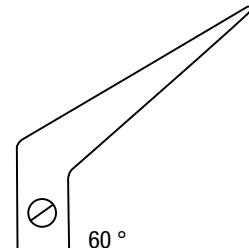

60°

DE BAKEY

		almedur		almedur		almedur
160 mm – 6¼"	308-486-160	411-979-250	308-487-160	411-979-450	308-488-160	411-979-600
230 mm – 9"	308-486-230	411-983-250	308-487-230	411-983-450	308-488-230	411-983-600
280 mm – 11"	308-486-280	411-984-250	308-487-280	411-984-450	308-488-280	411-984-600

Scheren Scissors



Gefäßscheren Artery scissors

Ciseaux vasculaires
Tijeras vasculares
Forbici vascolari

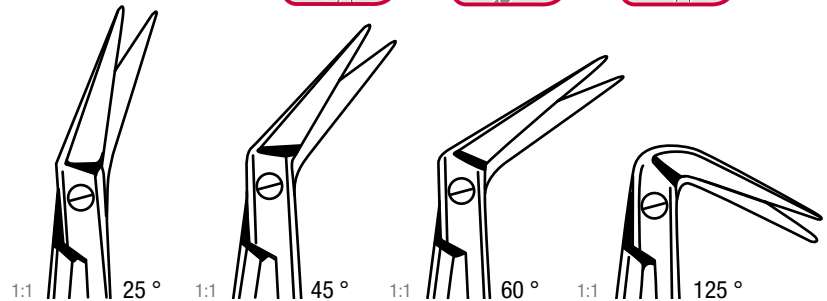

POTTS-SMITH	1:1	25°	1:1	45°	1:1	60°	1:1	125°
190 mm – 7 1/2"	03-525-025	03-525-045	03-525-060	03-525-125				

POTTS-SMITH	Supercut	Supercut	Supercut
190 mm – 7 1/2"	307-476-250	307-476-450	307-476-600

POTTS-SMITH	Ceramic Cut	Ceramic Cut	Ceramic Cut
190 mm – 7 1/2"	307-476-250K	307-476-450K	307-476-600K

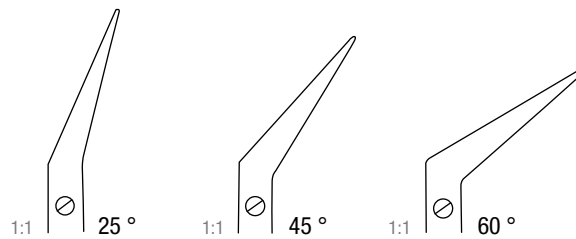

POTTS-SMITH	almedur	almedur	almedur
190 mm – 7 1/2"	308-480-250	308-480-400	308-480-600

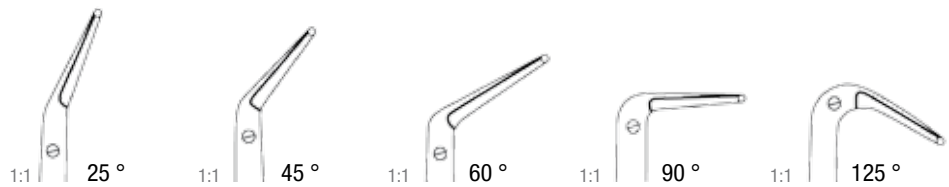

180 mm – 7"	411-767-250	411-767-450	411-767-600	411-767-900	411-768-000
-------------	-------------	-------------	-------------	-------------	-------------



411-766-250	411-766-450	411-766-600	411-766-900	411-767-000
-------------	-------------	-------------	-------------	-------------

Ceramic Cut	Ceramic Cut	Ceramic Cut	Ceramic Cut	Ceramic Cut
411-766-250K	411-766-450K	411-766-600K	411-766-900K	411-767-000K

Gefäßscheren

Artery scissors

Ciseaux vasculaires

Tijeras vasculares

Forbici vascolari



DIETRICH-HEGEMANN

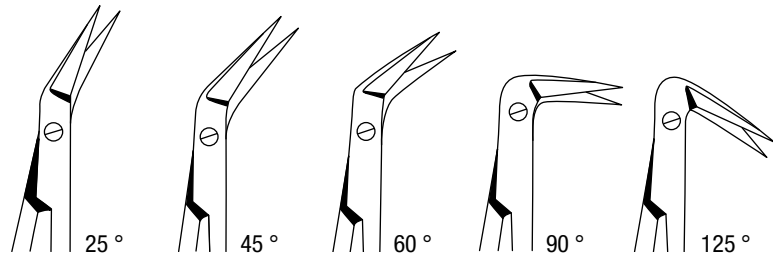

145 mm – 5 ¾"	03-531-025	03-531-045	03-531-060	03-531-090	03-531-125
160 mm – 6 ¼"	03-533-025	03-533-045	03-533-060	03-533-090	03-533-125
190 mm – 7 ½"	03-535-025	03-535-045	03-535-060	03-535-090	03-535-125

DIETRICH-HEGEMANN

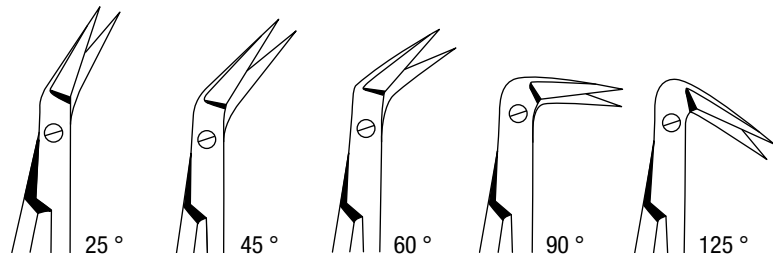

	Ceramic Cut	Ceramic Cut	Ceramic Cut	Ceramic Cut	Ceramic Cut
190 mm – 7 ½"	03-535-025K	03-535-045K	03-535-060K	03-535-090K	03-535-125K