

# Arterienklemmen

## Haemostatic forceps

**Arterienklemmen**  
*Haemostatic forceps*

*Pinces hémostatiques*  
*Pinzas hemostáticas*  
*Pinze emostatiche*

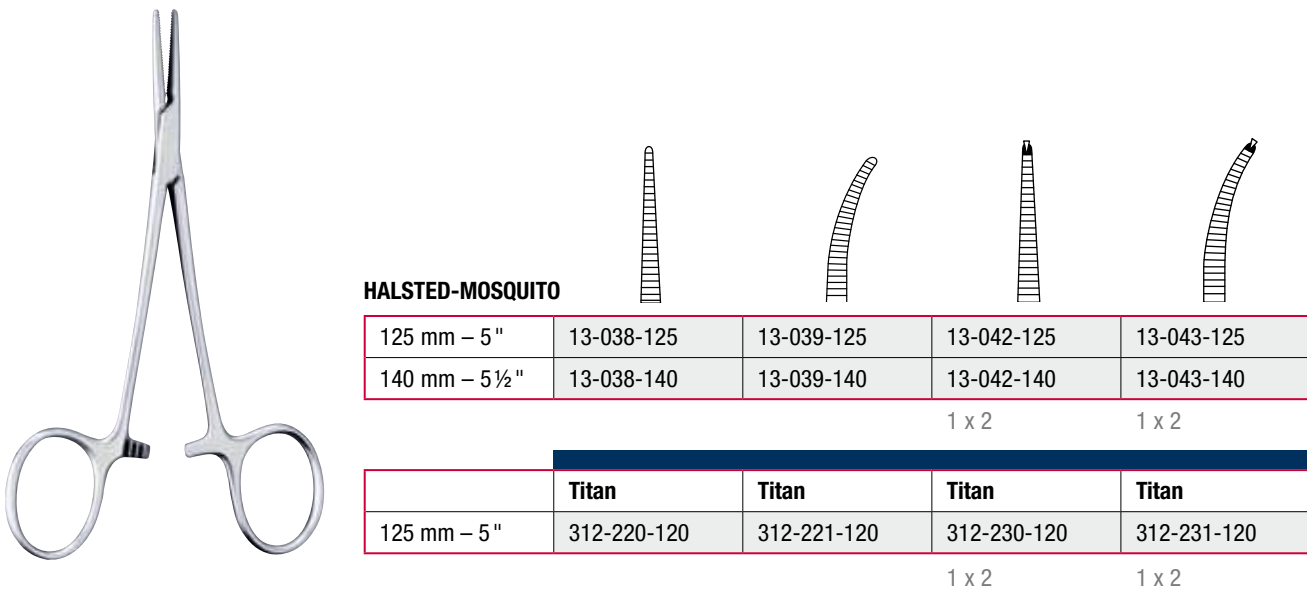
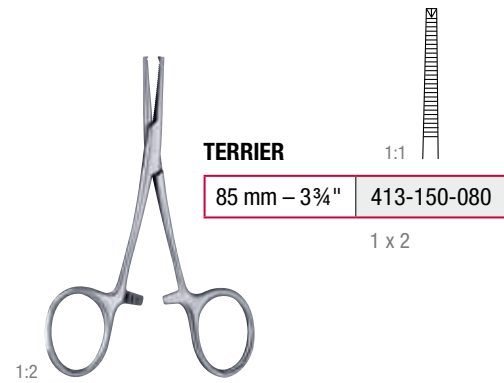
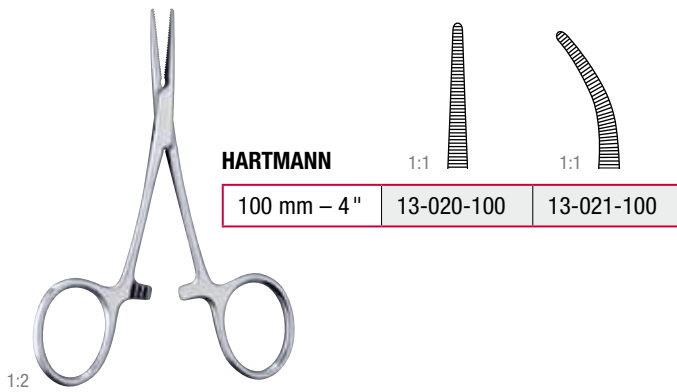

# Arterienklemmen

## Haemostatic forceps



**Arterienklemmen**  
*Haemostatic forceps*  
*Pinces hémostatiques*  
*Pinzas hemostáticas*  
*Pinze emostatiche*



**MICRO-MOSQUITO**

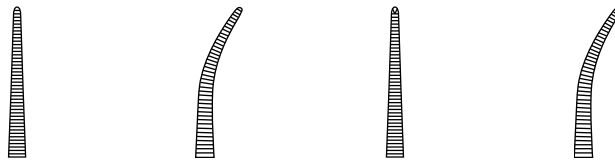

100 mm – 4"	13-028-100	13-029-100	13-030-100	13-031-100
120 mm – 4¾"	13-028-120	13-029-120	13-030-120	13-031-120

1 x 2

1 x 2

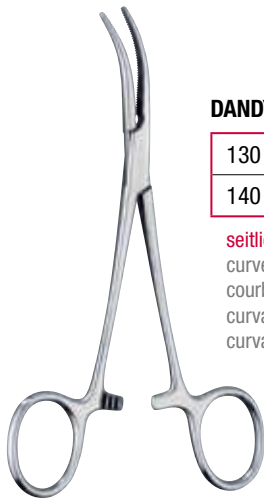

**DANDY**



130 mm – 4"	13-117-130	
140 mm – 5½"	13-117-140	413-353-140

1 x 2

**seitlich gebogen**  
 curved to the side  
 courbe sur le plat  
 curva al lado  
 curvata lateralmente



**MOSQUITO-DANDY**



1:1

120 mm – 4¾"	413-347-120
--------------	-------------

**seitlich gebogen**  
 curved to the side  
 courbe sur le plat  
 curva al lado  
 curvata lateralmente

1:2



**PROVIDENCE-HOSPITAL**

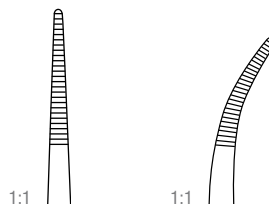

140 mm – 5½"	13-072-140	13-073-140
--------------	------------	------------

1:1

1:1

1:2

# Arterienklemmen

## Haemostatic forceps

**Arterienklemmen**  
*Haemostatic forceps*  
*Pinces hémostatiques*  
*Pinzas hemostáticas*  
*Pinze emostatiche*



**CHRISTOPHE**

130 mm – 4"	13-055-130
150 mm – 6"	13-055-150

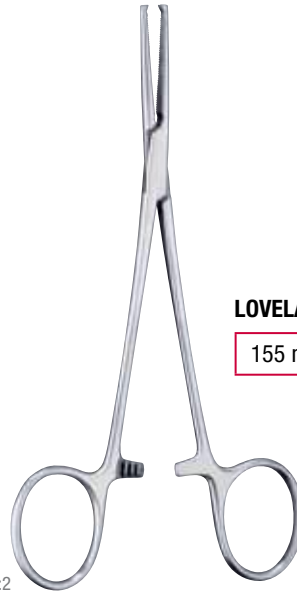
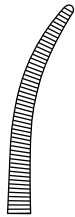

**LOVELACE**

155 mm – 6"	13-140-155	413-344-150
-------------	------------	-------------

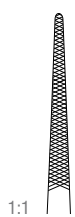
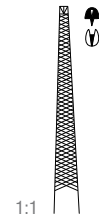

1 x 2

1:2



**LERICHE**

150 mm – 6"	312-376-150	312-377-150
-------------	-------------	-------------

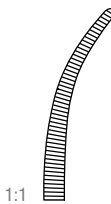
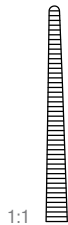

1:1

1:1

1:2



**LERICHE**

150 mm – 6"	312-378-150	312-379-150
-------------	-------------	-------------

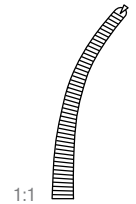

1:1

1:1

1 x 2

1:2

# Arterienklemmen

## Haemostatic forceps



**Arterienklemmen**  
*Haemostatic forceps*  
*Pinces hémostatiques*  
*Pinzas hemostáticas*  
*Pinze emostatiche*

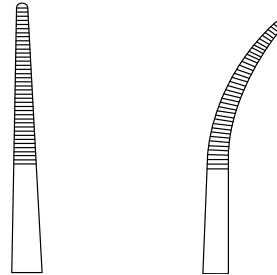

**KELLY**

140 mm – 5½"	13-078-140	13-079-140
--------------	------------	------------

**KELLY-RANKIN**

160 mm – 6¼"	13-082-160	13-083-160
--------------	------------	------------

**KELLY**

	Titan	Titan
140 mm – 5½"	312-240-140	312-241-140

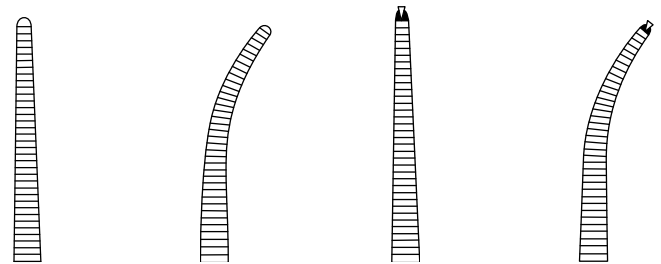

**CRILE**

140 mm – 5½"	13-090-140	13-091-140	13-092-140	13-093-140
			1 x 2	1 x 2

**CRILE-RANKIN**

160 mm – 6¼"	13-100-160	13-101-160	312-260-160	312-261-160
			1 x 2	1 x 2

**CRILE**

	Titan	Titan
140 mm – 5½"	312-250-140	312-251-140

# Arterienklemmen

## Haemostatic forceps

**Arterienklemmen**  
*Haemostatic forceps*

*Pinces hémostatiques*  
*Pinzas hemostáticas*  
*Pinze emostatiche*



**COLLER-CRILE**

140 mm – 5 ½"	312-262-140	312-263-140
160 mm – 6 ¼"	312-262-160	312-263-160

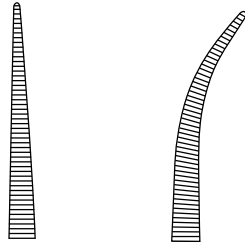

**PÉAN**

130 mm – 5"	413-370-130	413-371-130
140 mm – 5 ½"	312-308-140	312-309-140
160 mm – 6 ¼"	413-370-160	413-371-160

**graziles Modell**  
delicate pattern  
modèle délicat  
modelo delicado  
modello delicato

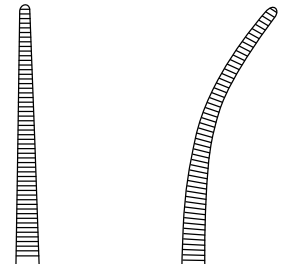

**DUNHILL**

125 mm – 5"	312-272-130	12-273-130
-------------	-------------	------------

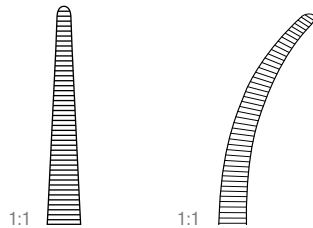

**gebogen**  
curved  
courbe  
curva  
curvo

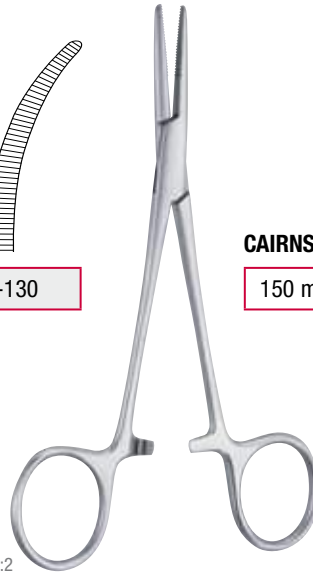

**CAIRNS**

150 mm – 6"	312-270-140	312-271-140
-------------	-------------	-------------

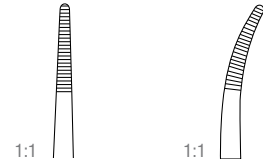

1:2

1:2



**KOCHER**

130 mm – 5"	413-380-130	413-381-130
140 mm – 5 ½"	312-318-140	312-319-140
160 mm – 6 ¼"	312-318-160	413-381-160

1 x 2

1 x 2

**graziles Modell**  
delicate pattern  
modèle délicat  
modelo delicado  
modello delicato

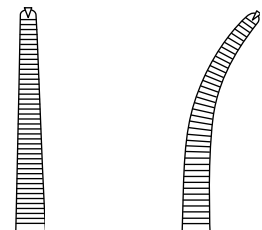

# Arterienklemmen

## Haemostatic forceps



04

**Arterienklemmen**  
*Haemostatic forceps*  
*Pinces hémostatiques*  
*Pinzas hemostáticas*  
*Pinze emostatiche*

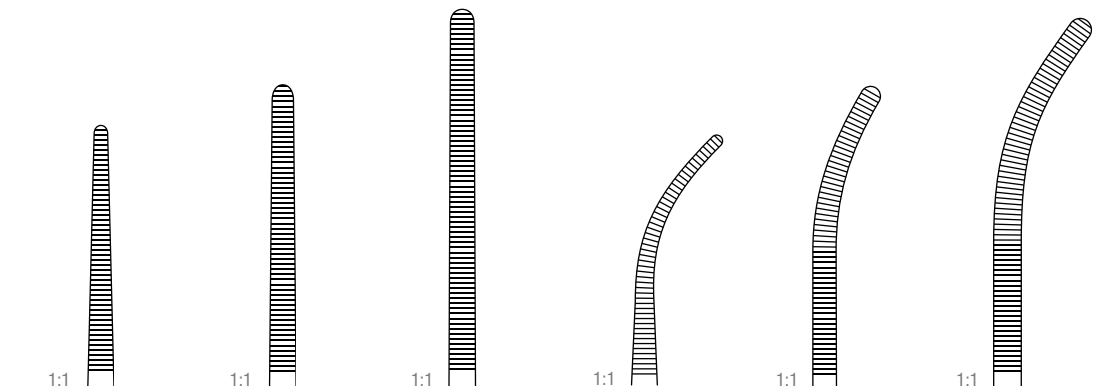

**PÉAN-FINO**

140 mm – 5 ½ "	165 mm – 6 ½ "	185 mm – 7 ¼ "	140 mm – 5 ½ "	160 mm – 6 ¼ "	180 mm – 7 "
413-376-140	413-376-160	413-376-180	413-377-140	413-377-160	413-377-180

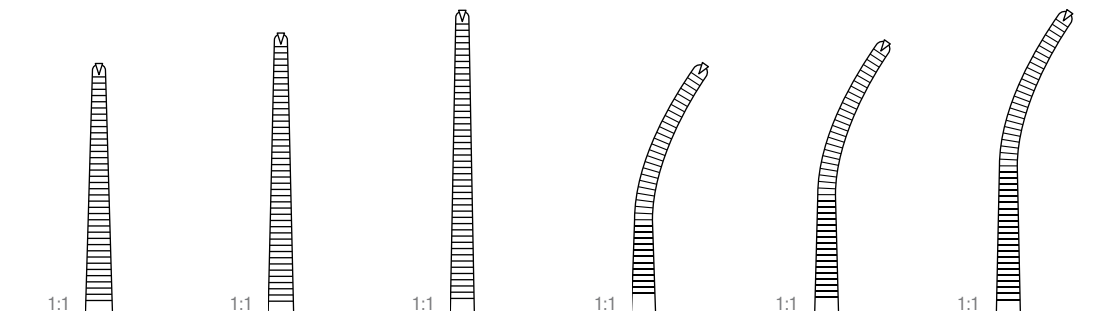

**KOCHER-FINO**

145 mm – 5 ¾ "	165 mm – 6 ½ "	185 mm – 7 ¼ "	145 mm – 5 ¾ "	160 mm – 6 ¼ "	180 mm – 7 "
413-378-140	413-378-160	413-378-180	413-379-140	413-379-160	413-379-180

1 x 2

1 x 2

1 x 2

1 x 2

1 x 2

1 x 2

# Arterienklemmen

## Haemostatic forceps

**Arterienklemmen**  
*Haemostatic forceps*

*Pinces hémostatiques*  
*Pinzas hemostáticas*  
*Pinze emostatiche*

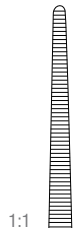
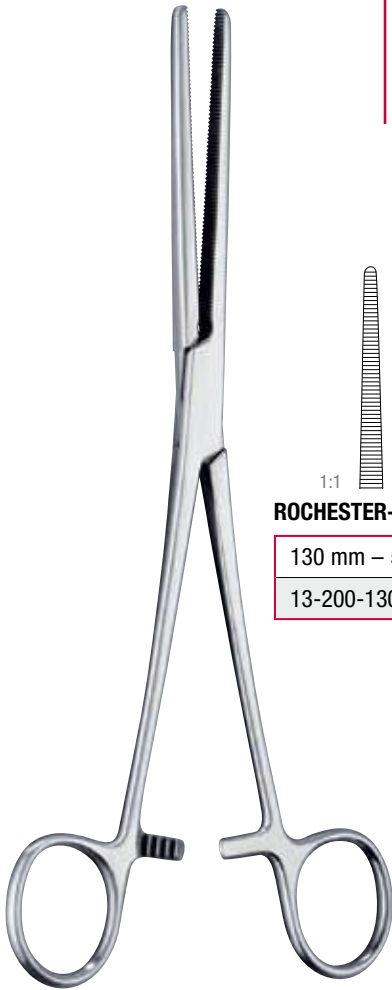

ROCHESTER-PÉAN

130 mm – 5"	140 mm – 5½"	160 mm – 6¼"	180 mm – 7"	200 mm – 8"
13-200-130	13-200-140	13-200-160	13-200-180	13-200-200

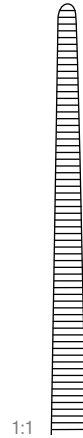
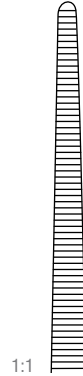
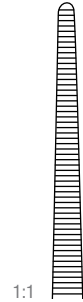

Atrauma	Atrauma	Atrauma	Atrauma
140 mm – 5½"	160 mm – 6¼"	180 mm – 7"	200 mm – 8"
313-078-140	313-078-160	313-078-180	313-078-200

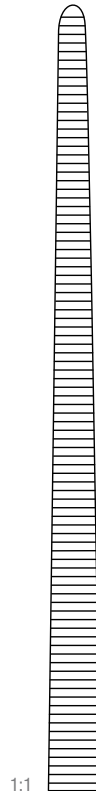
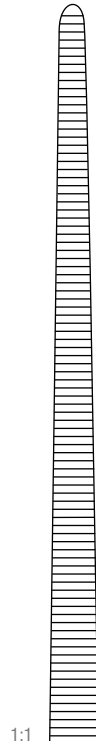
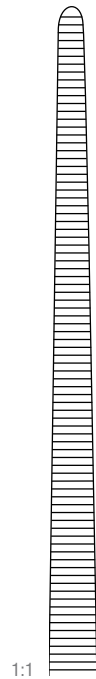
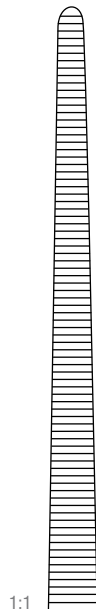
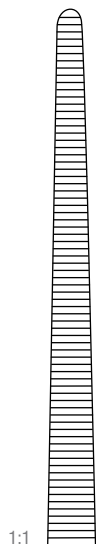

220 mm – 8¾"	240 mm – 9½"	260 mm – 10¼"	300 mm – 12"	350 mm – 14"
13-200-220	13-200-240	13-200-260	13-200-300	13-200-350

Atrauma	Atrauma
260 mm – 10¼"	300 mm – 12"
313-078-265	313-078-280

# Arterienklemmen

## Haemostatic forceps



**Arterienklemmen**  
*Haemostatic forceps*  
*Pinces hémostatiques*  
*Pinzas hemostáticas*  
*Pinze emostatiche*

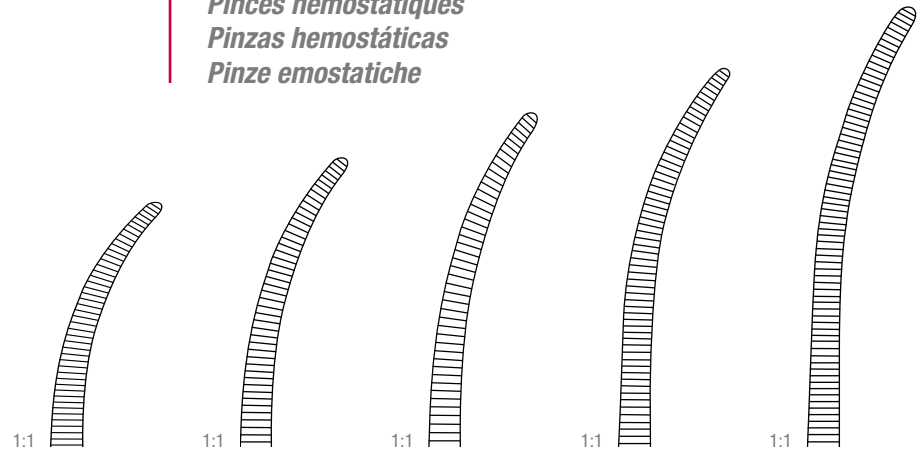

**ROCHESTER-PÉAN**

130 mm – 5"	140 mm – 5½"	160 mm – 6¼"	180 mm – 7"	200 mm – 8"
13-201-130	13-201-140	13-201-160	13-201-180	13-201-200

Atrauma	Atrauma	Atrauma	Atrauma
140 mm – 5½"	160 mm – 6¼"	180 mm – 7"	200 mm – 8"
313-079-140	313-079-160	313-079-180	313-079-200

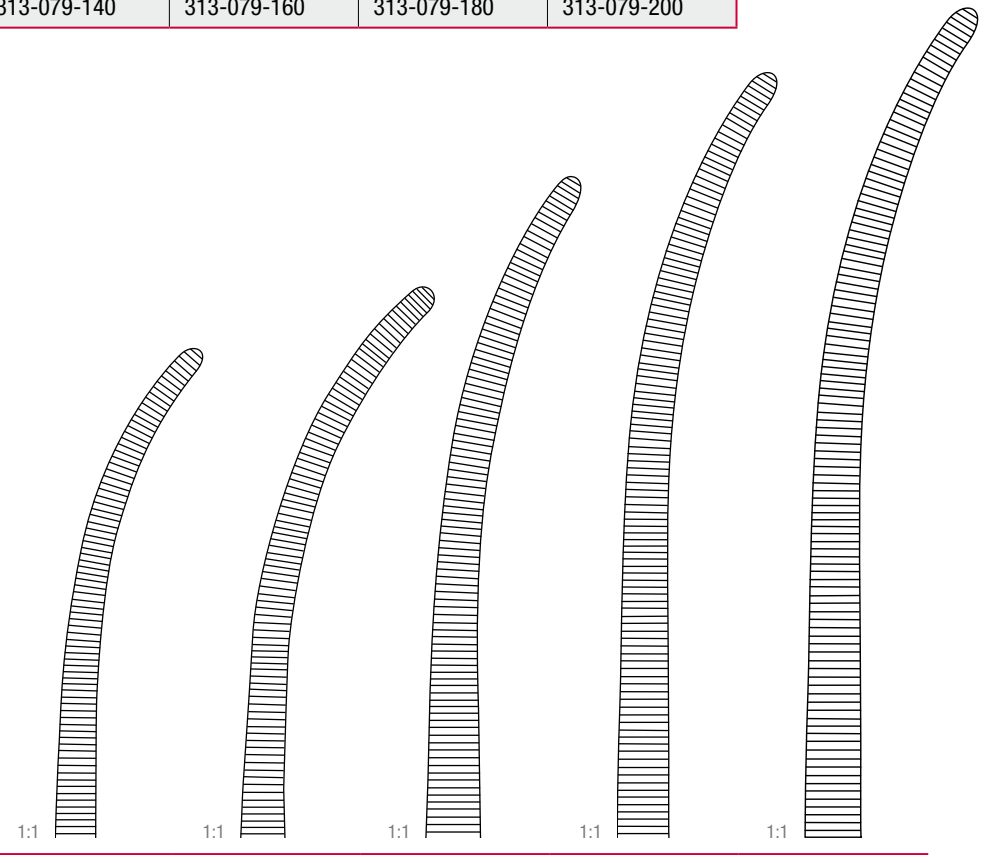

220 mm – 8¾"	240 mm – 9½"	260 mm – 10¼"	300 mm – 12"	350 mm – 14"
13-201-220	13-201-240	13-201-260	13-201-300	13-201-350

Atrauma	Atrauma
260 mm – 10¼"	300 mm – 12"
313-079-260	313-079-275



# Arterienklemmen

## Haemostatic forceps

**Arterienklemmen**  
*Haemostatic forceps*

*Pinces hémostatiques*  
*Pinzas hemostáticas*  
*Pinze emostatiche*

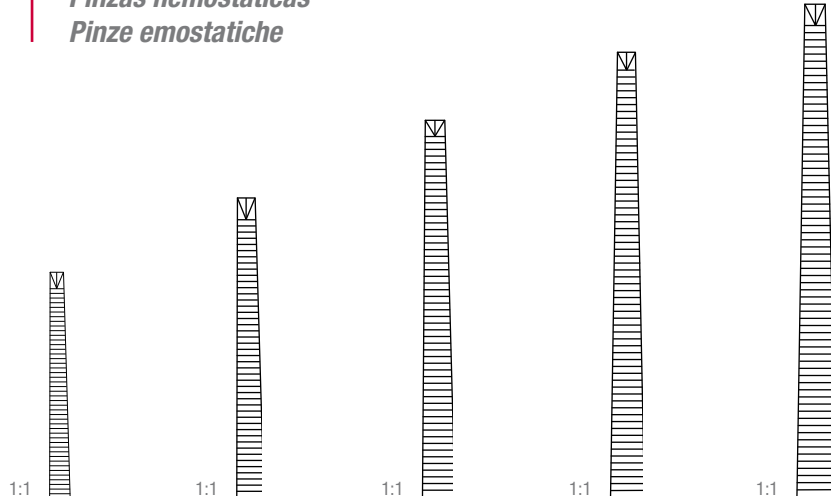

**OCHSNER-KOCHER**

130 mm – 5"	140 mm – 5½"	160 mm – 6¼"	180 mm – 7"	200 mm – 8"
13-214-130	13-214-140	13-214-160	13-214-180	13-214-200

1 x 2

1 x 2

1 x 2

1 x 2

1 x 2

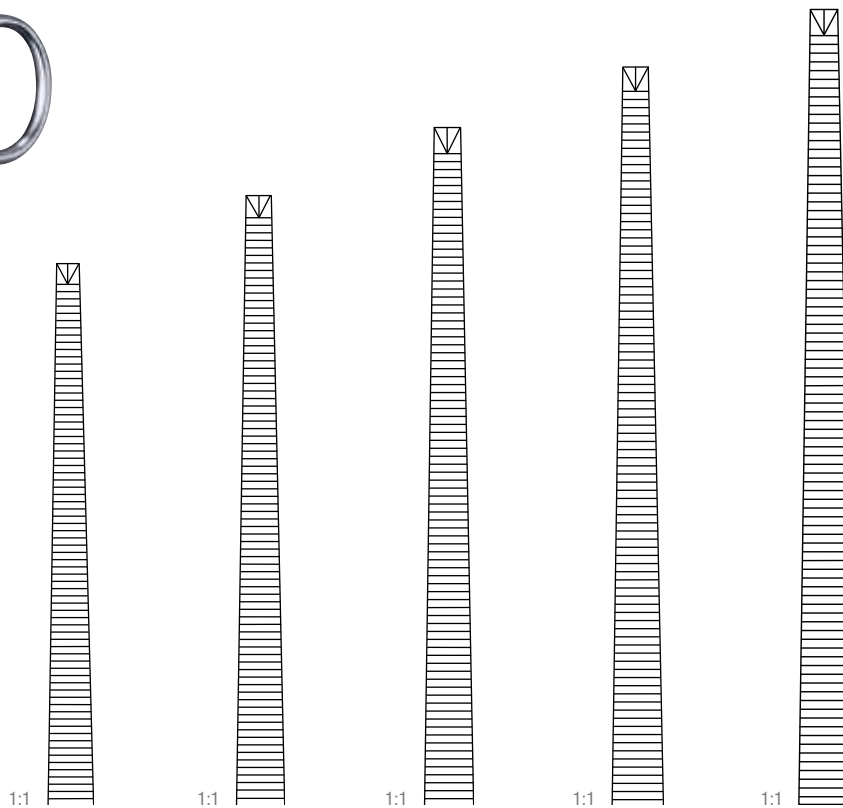

220 mm – 8¾"	240 mm – 9½"	260 mm – 10¼"	300 mm – 12"	300 mm – 14"
13-214-220	13-214-240	13-214-260	13-214-300	13-214-350

1 x 2

1 x 2

1 x 2

1 x 2

1 x 2

# Arterienklemmen

## Haemostatic forceps



**Arterienklemmen**  
*Haemostatic forceps*  
*Pinces hémostatiques*  
*Pinzas hemostáticas*  
*Pinze emostatiche*

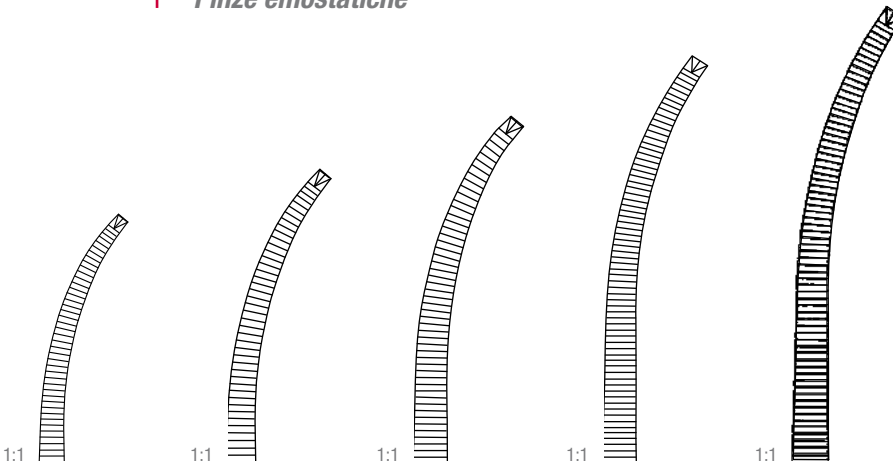

**OCHSNER-KOCHER**

130 mm – 5"	140 mm – 5½"	160 mm – 6¼"	180 mm – 7"	200 mm – 8"
13-215-130	13-215-140	13-215-160	13-215-180	13-215-200

1 x 2      1 x 2      1 x 2      1 x 2      1 x 2

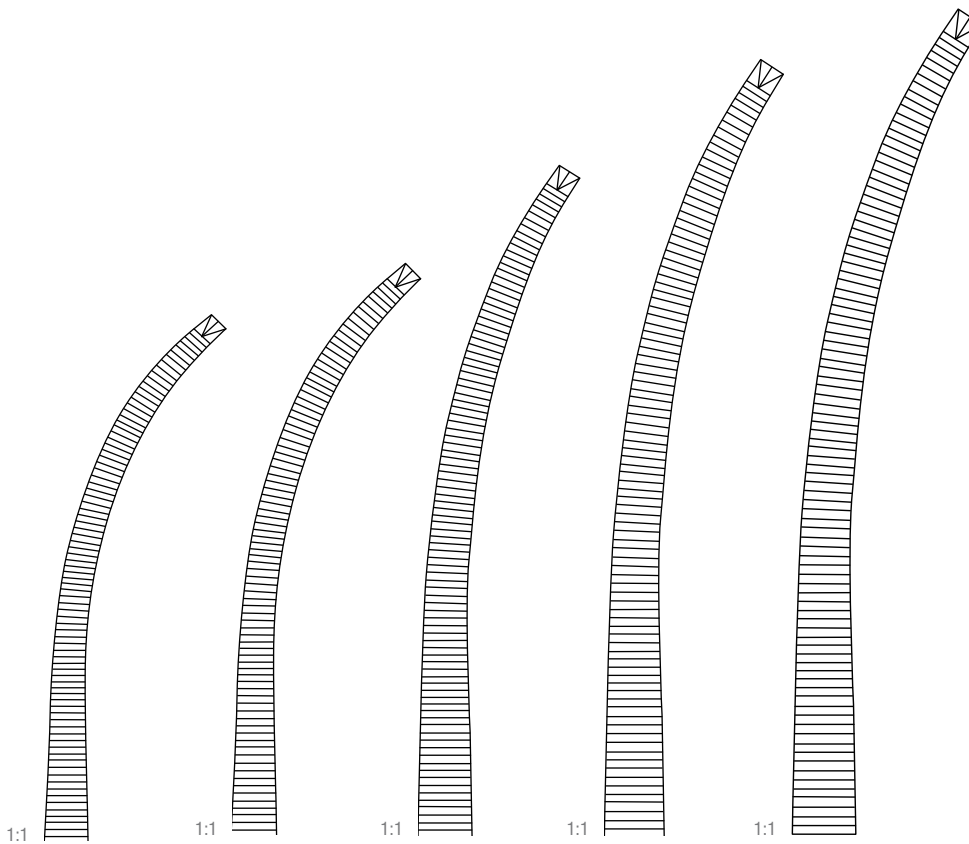

220 mm – 8¾"	240 mm – 9½"	260 mm – 10¼"	300 mm – 12"	350 mm – 14"
13-215-220	13-215-240	13-215-260	13-215-300	13-215-350

1 x 2      1 x 2      1 x 2      1 x 2      1 x 2

# Arterienklemmen

## Haemostatic forceps

**Arterienklemmen**  
*Haemostatic forceps*  
*Pinces hémostatiques*  
*Pinzas hemostáticas*  
*Pinze emostatiche*



**BIRKETT**

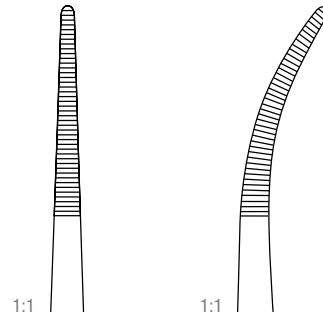

190 mm – 7½"	13-228-180	13-229-180
--------------	------------	------------



**BAINBRIDGE**

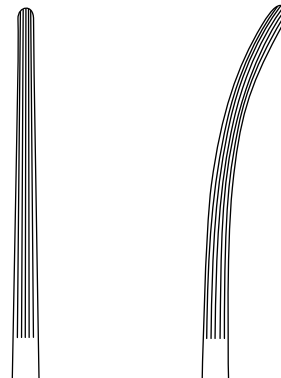

150 mm – 6"	13-148-150	13-149-150
185 mm – 7¼"	13-148-185	13-149-185

# Arterienklemmen

## Haemostatic forceps



**Arterienklemmen**  
*Haemostatic forceps*  
*Pinces hémostatiques*  
*Pinzas hemostáticas*  
*Pinze emostatiche*



**PÉAN**

140 mm – 5 ½ "	13-184-140
160 mm – 6 ¼ "	13-184-160

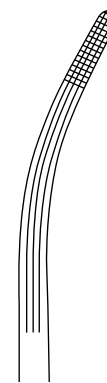

**ROCHESTER-CARMALT**

160 mm – 6 ¼ "	13-180-160	13-181-160
200 mm – 8 "	13-180-200	13-181-200

# Arterienklemmen

## Haemostatic forceps

**Arterienklemmen**  
*Haemostatic forceps*

*Pinces hémostatiques*  
*Pinzas hemostáticas*  
*Pinze emostatiche*

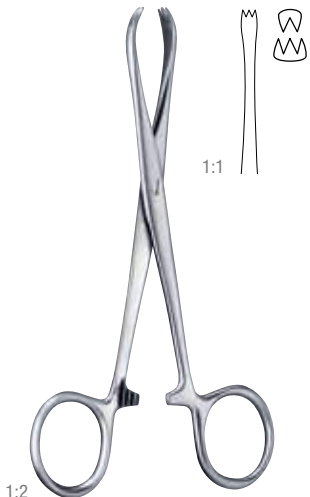

1:2

**CHAPUT**

130 mm – 5"

312-366-130

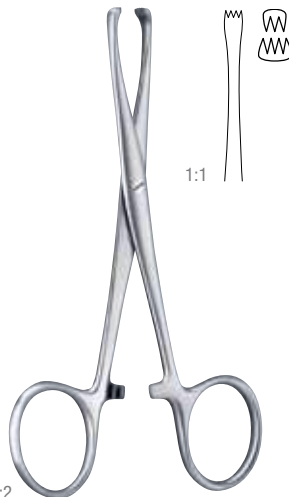

1:2

**TUFFIER**

130 mm – 5"

312-368-130



**PENNINGTON**

155 mm – 6"

13-124-155

200 mm – 8"

13-124-200



1:2

**COLLIN**

140 mm – 5½"

312-370-140



1:2

**PRATT**

150 mm – 6"

13-134-150



1:2

**MARTEL**

140 mm – 5½"

312-360-140

# Arterienklemmen

## Haemostatic forceps



**Arterienklemmen**  
*Haemostatic forceps*  
*Pinces hémostatiques*  
*Pinzas hemostáticas*  
*Pinze emostatiche*



**FERGUSSON**

160 mm – 6 ¼ "	312-346-160	312-367-160
200 mm – 8 "	312-346-200	312-367-200

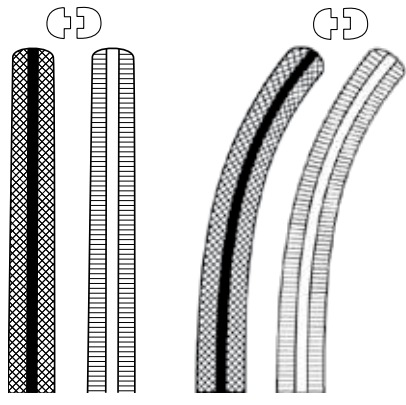

gebogen  
 curved  
 courbe  
 curva  
 curvo



**SPENCER-WELLS**

130 mm – 5 "	13-190-130	13-191-130
140 mm – 5 ½ "	13-190-140	13-191-140
155 mm – 6 "	13-190-150	13-191-150
180 mm – 7 "	13-190-180	13-191-180
200 mm – 8 "	13-190-200	13-191-200

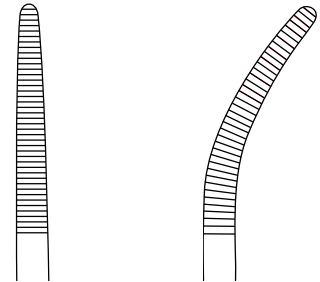

**HALSTED-MOSQUITO**

180 mm – 7 "	13-048-180	13-049-180	13-050-180	13-051-180
210 mm – 8 ¼ "	312-216-210	312-217-210	312-226-210	312-227-210

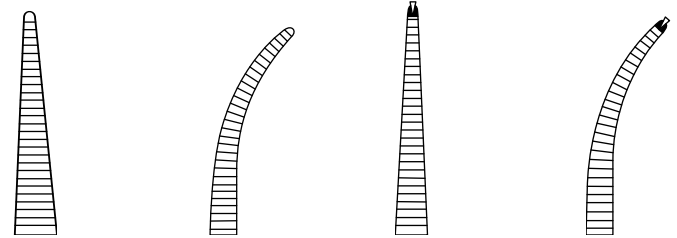

1 x 2

1 x 2

# Arterienklemmen

## Haemostatic forceps

**Arterienklemmen**  
*Haemostatic forceps*  
*Pinces hémostatiques*  
*Pinzas hemostáticas*  
*Pinze emostatiche*

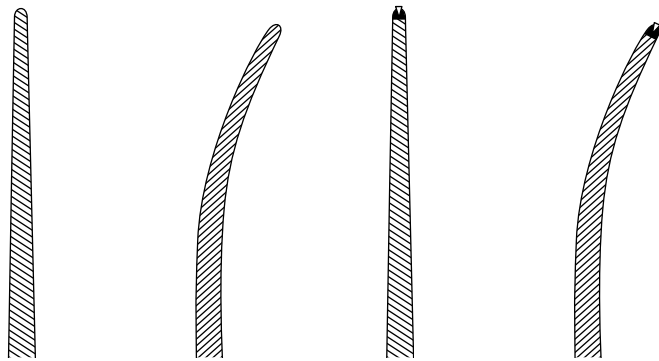

**BENGOLEA**

200 mm – 8"	13-240-200	13-241-200	13-242-200	13-243-200
260 mm – 10¼"	13-240-260	13-241-260	13-242-260	13-243-260

1 x 2

1 x 2

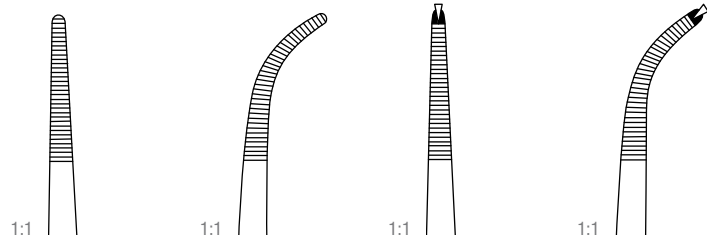

**ADSON**

185 mm – 7¼"	13-160-185	13-161-185	13-166-185	13-167-185
--------------	------------	------------	------------	------------

1 x 2

1 x 2

1:2

# Arterienklemmen

## Haemostatic forceps



04

**Arterienklemmen**  
*Haemostatic forceps*  
*Pinces hémostatiques*  
*Pinzas hemostáticas*  
*Pinze emostatiche*

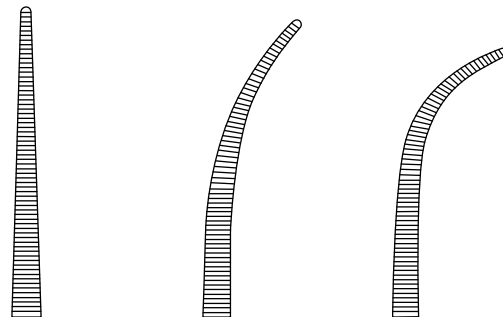

**HEISS**

200 mm – 8"	13-224-200	13-225-200	13-227-200
230 mm – 9"	13-224-230	13-225-230	13-227-230



# Arterienklemmen

## Haemostatic forceps

**Arterienklemmen**  
*Haemostatic forceps*  
*Pinces hémostatiques*  
*Pinzas hemostáticas*  
*Pinze emostatiche*



**BABY-MIXTER**

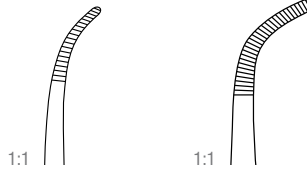

140 mm – 5 ½"	312-471-140	
180 mm – 7"		312-471-180



**BABY-ADSON**

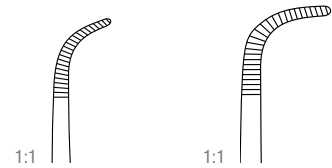

140 mm – 5 ½"	413-417-140	
180 mm – 7"		312-411-180

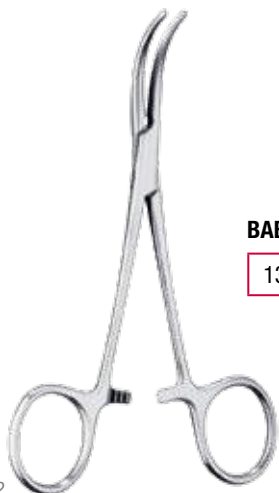

**BABY-OVERHOLT**

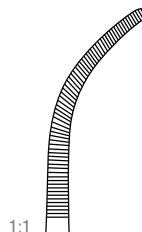

135 mm – 5 ¼"	413-335-140
---------------	-------------

1:2

# Arterienklemmen

## Haemostatic forceps



**Arterienklemmen**  
*Haemostatic forceps*  
*Pinces hémostatiques*  
*Pinzas hemostáticas*  
*Pinze emostatiche*

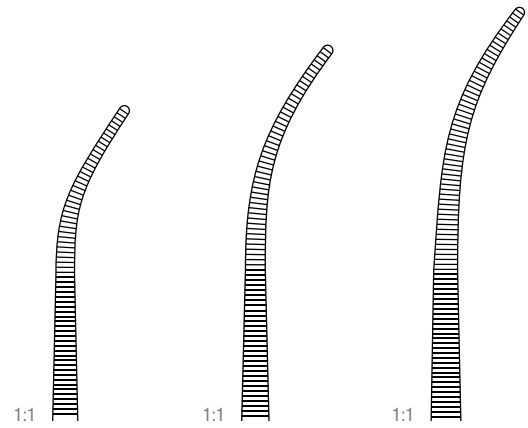
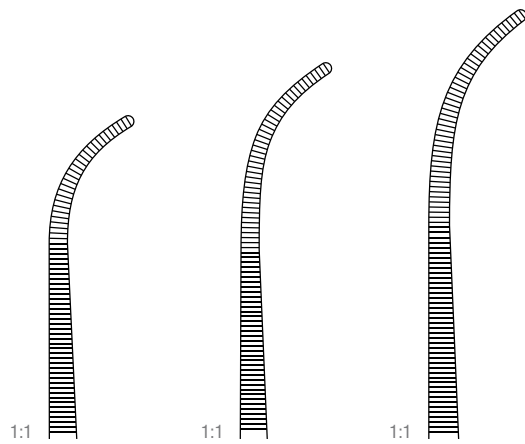

Fig. 1	Fig. 1	Fig. 1
195 mm – 7 ¾"	225 mm – 8 ¾"	245 mm – 9 ¾"
413-573-190	413-573-220	413-573-240



**KELLY-FRASER**

Fig. 2	Fig. 2	Fig. 2
190 mm – 7 ½"	220 mm – 8 ¾"	240 mm – 9 ½"
413-575-190	413-575-220	413-575-240

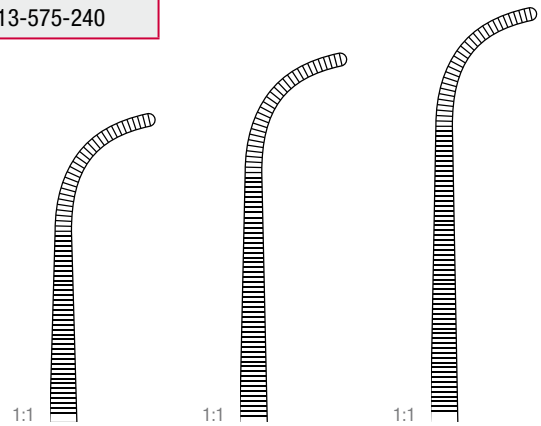

Fig. 3	Fig. 3	Fig. 3
185 mm – 7 ¼"	215 mm – 8 ½"	235 mm – 9 ¼"
413-577-190	413-577-220	413-577-240

# Arterienklemmen

## Haemostatic forceps

**Arterienklemmen**  
*Haemostatic forceps*  
*Pinces hémostatiques*  
*Pinzas hemostáticas*  
*Pinze emostatiche*



1:2

**SCHNIDT**

1:1

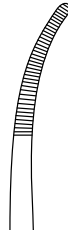

1:1

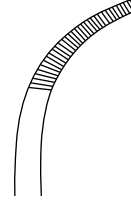

190 mm – 7 ½"	13-531-190	13-533-190
---------------	------------	------------



**TOENNIS**

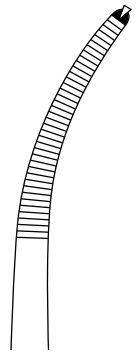
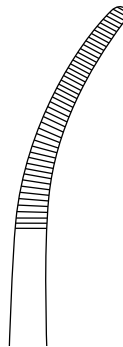

210 mm – 8 ¼"	312-438-210	312-439-210	312-440-210	312-441-210
260 mm – 10 ¼"	312-438-260	312-439-260	312-440-260	312-441-260

1 x 2

1 x 2

# Arterienklemmen

## Haemostatic forceps



**Arterienklemmen**  
*Haemostatic forceps*  
*Pinces hémostatiques*  
*Pinzas hemostáticas*  
*Pinze emostatiche*

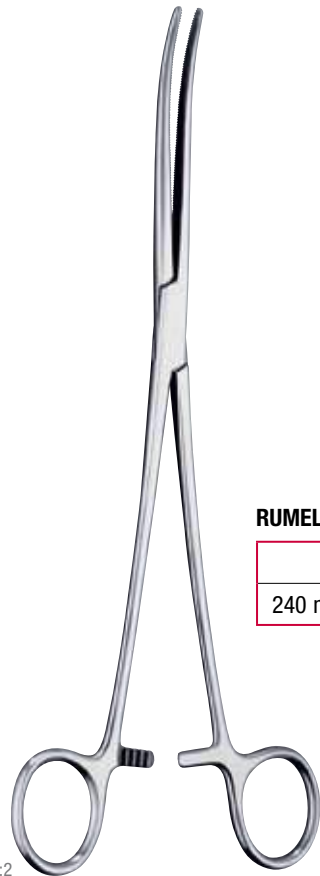

1:2

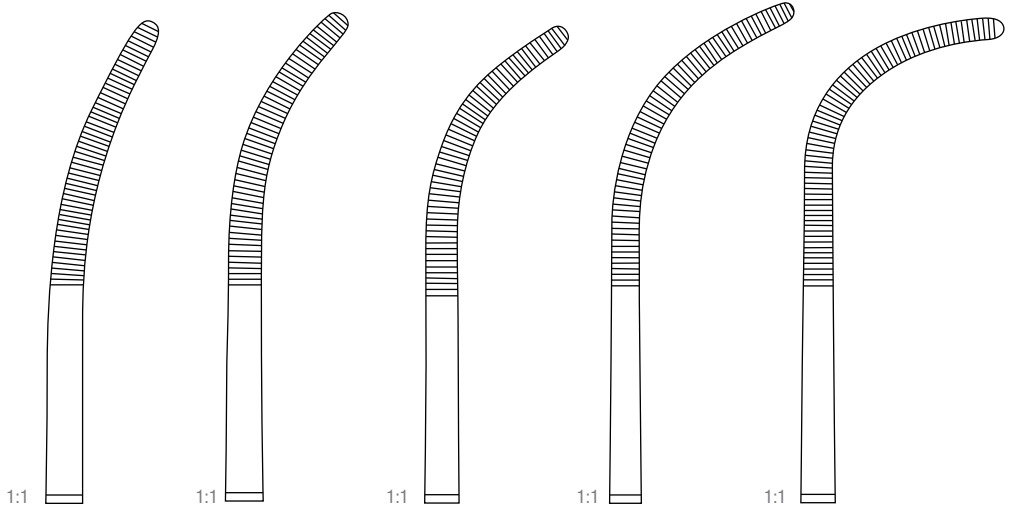

**RUMEL**

	Fig. 1	Fig. 2	Fig. 3	Fig. 4	Fig. 5
240 mm – 9½"	13-485-001	13-485-002	13-485-003	13-485-004	13-485-005



**MEEKER**

180 mm – 7"	312-455-180
275 mm – 10¾"	312-455-280

gebogen, 90°  
 curved, 90°  
 courbe, 90°  
 curva, 90°  
 curve, 90°

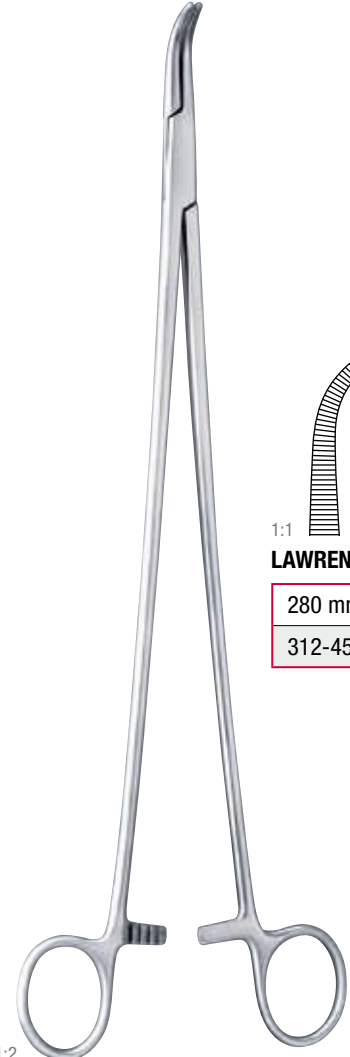
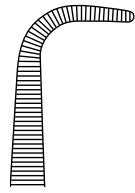

1:2

**LAWRENCE**

280 mm – 11"	312-453-280
--------------	-------------

