



Knochenmeißel

Bone chisels and gouges

Ciseaux-burins, gouges

Cinceles, gubias

Scalpelli, sgorbi



1:2

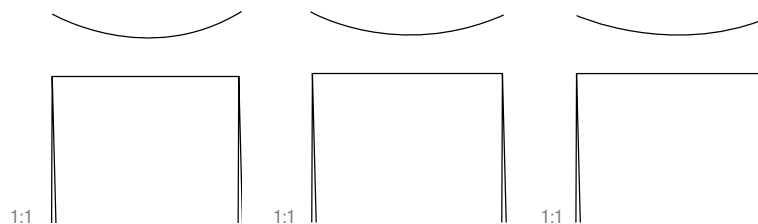

1:1

1:1

1:1

	25 mm (r = 50 mm)	25 mm (r = 60 mm)	25 mm (r = 70 mm)
135 mm – 5¼"	332-577-500	332-577-600	332-577-700

Hohlmeißelklingen, auswechselbar

Gouge blades, interchangeable
 Lames gouges, interchangeables
 Hojas de gubia, intercambiables
 Lame intercambiabili, concavo

Knochenmeißel
Bone chisels and gouges
Ciseaux-burins, gouges
Cinceles, gubias
Scalpelli, sgorbi



1:2

185 mm – 7 ¼"

332-576-000

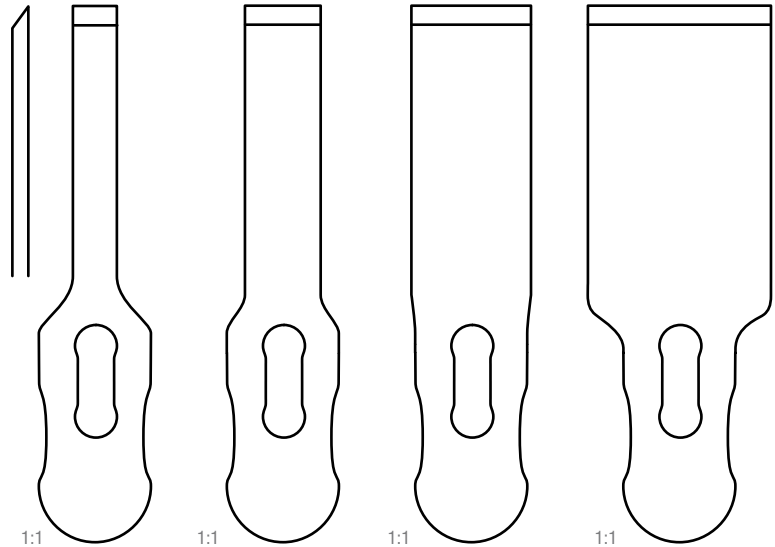

	5 mm	10 mm	16 mm	25 mm
85 mm – 3 ¼"	332-576-050	332-576-100	332-576-160	332-576-250

Meißelklingen, auswechselbar
Chisel blades, interchangeable
Lames ciseaux-burin, interchangeables
Hojas de cincel, intercambiables
Lame, intercambiabili

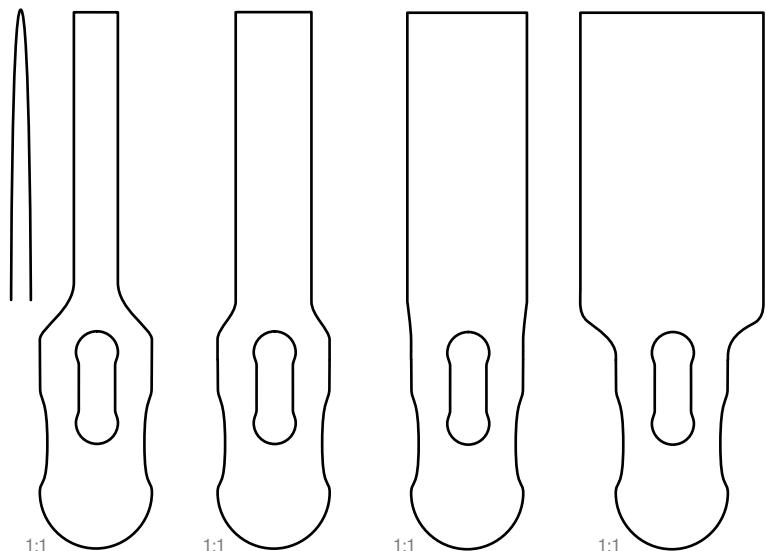

	5 mm	10 mm	16 mm	25 mm
85 mm – 3 ¼"	332-576-005	332-576-010	332-576-016	332-576-025

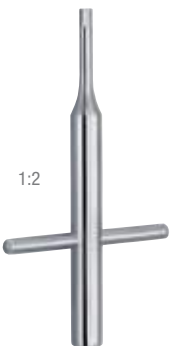

1:2

90 mm – 3 ½"

332-576-990

Spannschlüssel
Key
Clé
Llave
Chiave

Osteotomklingen, auswechselbar
Osteotome blades, interchangeable
Lames d'osteotomos interchangeables
Hojas de osteótomo, intercambiables
Lame per osteotomia, intercambiabili



Knochenmeißel

Bone chisels and gouges

Ciseaux-burins, gouges

Cinceles, gubias

Scalpelli, sgorbi

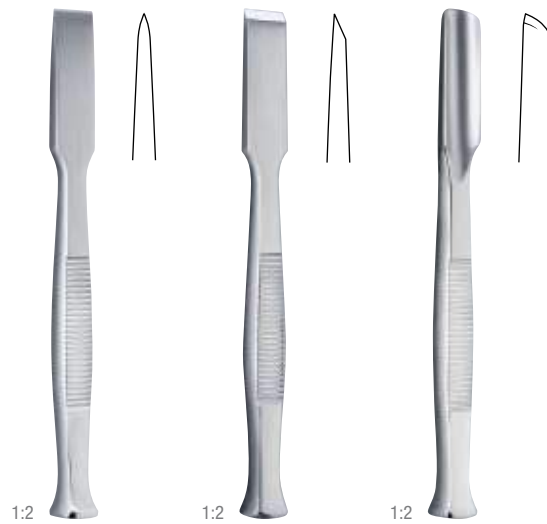

	135 mm – 5 ¼"	135 mm – 5 ¼"	135 mm – 5 ¼"
4 mm			67-504-004
6 mm	67-500-006	67-502-006	67-504-006
8 mm	67-500-008	67-502-008	67-504-008
10 mm	67-500-010	67-502-010	67-504-010
12 mm	67-500-012	67-502-012	67-504-012
14 mm	67-500-014	67-502-014	67-504-014
16 mm	67-500-016	67-502-016	67-504-016

Knochenmeißel
Bone chisels and gouges
Ciseaux-burins, gouges
Cinceles, gubias
Scalpelli, sgorbi



ALEXANDER

1:2

1:2

	180 mm – 7"	180 mm – 7"
4 mm	67-520-004	67-522-004
6 mm	67-520-006	67-522-006
8 mm	67-520-008	67-522-008
10 mm	67-520-010	67-522-010
12 mm	67-520-012	67-522-012
14 mm	67-520-014	67-522-014



LUCAS

1:2

1:2

	160 mm – 6¼"	160 mm – 6¼"
3 mm		67-532-003
4 mm	67-530-004	
6 mm	67-530-006	67-532-006

Flachmeißel
Chisel
Ciseau burin
Cinzel
Scalpello

Hohlmeißel
Gouge
Gouge
Gubia
Sgorbi



Knochenmeißel

Bone chisels and gouges

Ciseaux-burins, gouges

Cinceles, gubias

Scalpelli, sgorbi



PARTSCH

	115 mm – 4½"	135 mm – 5¼"	170 mm – 6¾"
2 mm	423-100-020	67-510-002	332-618-020
3 mm	423-100-030	67-510-003	332-618-030
4 mm	423-100-040	67-510-004	332-618-040
5 mm	423-100-050	67-510-005	332-618-050
6 mm	423-100-060	67-510-006	332-618-060
7 mm	423-100-070	67-510-007	332-618-070
8 mm	423-100-080	67-510-008	332-618-080



	115 mm – 4½"	135 mm – 5¼"	170 mm – 6¾"
	423-104-020	67-512-002	332-621-020
	423-104-030	67-512-003	332-621-030
	423-104-040	67-512-004	332-621-040
	423-104-050	67-512-005	332-621-050
	423-104-060	67-512-006	332-621-060
	423-104-070	67-512-007	332-621-070
	423-104-080	67-512-008	332-621-080

Knochenmeißel
Bone chisels and gouges
Ciseaux-burins, gouges
Cinceles, gubias
Scalpelli, sgorbi



LAMBOTTE

	250 mm – 9¾"	250 mm – 9¾"
4 mm	67-550-004	67-551-004
6 mm	67-550-006	67-551-006
8 mm	67-550-008	67-551-008
10 mm	67-550-010	67-551-010
13 mm	67-550-013	67-551-013
15 mm	67-550-015	67-551-015
20 mm	67-550-020	67-551-020
25 mm	67-550-025	67-551-025
30 mm	67-550-030	67-551-030
38 mm	67-550-038	67-551-038
44 mm	67-550-044	67-551-044
50 mm	67-550-050	67-551-050



MINI-LAMBOTTE

	125 mm – 5"	170 mm – 6¾"
3 mm	332-650-030	423-132-530
4 mm	332-650-040	423-132-540
6 mm	332-650-060	423-132-560
8 mm	332-650-080	423-132-580
10 mm	332-650-100	423-132-600
12 mm	332-650-120	423-132-620
14 mm	332-650-140	
15 mm	332-650-150	423-132-650
18 mm	332-650-180	
20 mm	332-650-200	

Knochenchirurgie

Bone surgery



09

Knochenmeißel
Bone chisels and gouges
Ciseaux-burins, gouges
Cinceles, gubias
Scalpelli, sgorbi



LEXER

1:2

1:2

	220 mm – 8 3/4"	220 mm – 8 3/4"
5 mm	67-540-005	67-542-005
7 mm	67-540-007	67-542-007
10 mm	67-540-010	67-542-010
15 mm	67-540-015	67-542-015
20 mm	67-540-020	67-542-020
25 mm	67-540-025	67-542-025
30 mm	67-540-030	67-542-030

Ferrozellgriff
 Ferrozell handle
 Manche en Ferrozell
 Mango en Ferrozell
 Manico di Ferrozell

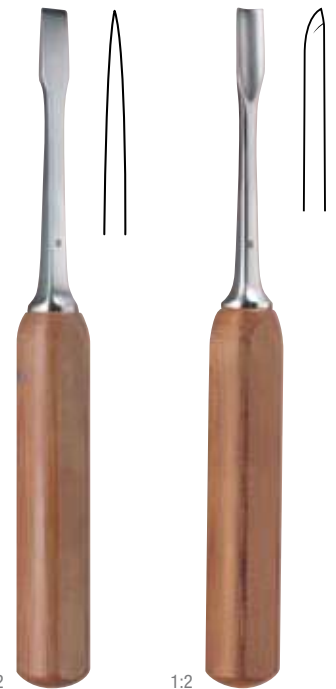

MINI-LEXER

1:2

1:2

	180 mm – 7"	180 mm – 7"
4 mm	332-660-040	332-661-040
6 mm	332-660-060	332-661-060
8 mm	332-660-080	332-661-080
10 mm	332-660-100	332-661-100
12 mm	332-660-120	332-661-120

Ferrozellgriff
 Ferrozell handle
 Manche en Ferrozell
 Mango en Ferrozell
 Manico di Ferrozell

Knochenmeißel
Bone chisels and gouges
Ciseaux-burins, gouges
Cinceles, gubias
Scalpelli, sgorbi

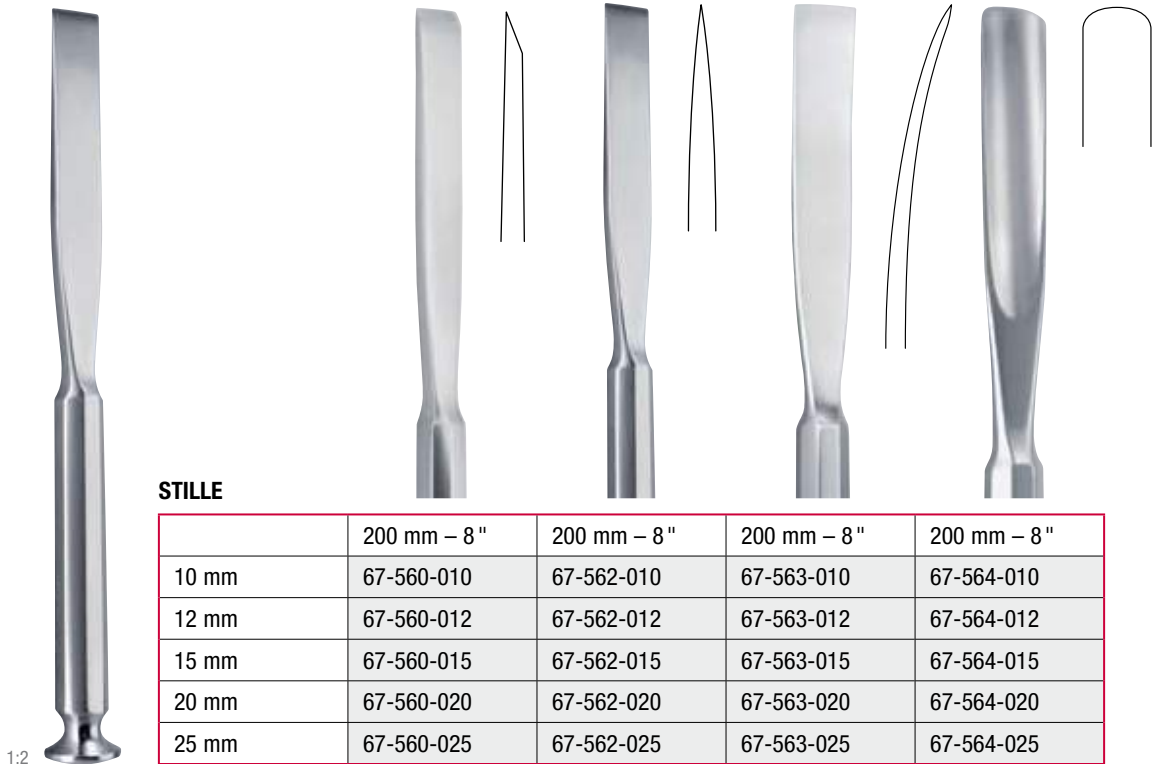

STILLE

	200 mm – 8"	200 mm – 8"	200 mm – 8"	200 mm – 8"
10 mm	67-560-010	67-562-010	67-563-010	67-564-010
12 mm	67-560-012	67-562-012	67-563-012	67-564-012
15 mm	67-560-015	67-562-015	67-563-015	67-564-015
20 mm	67-560-020	67-562-020	67-563-020	67-564-020
25 mm	67-560-025	67-562-025	67-563-025	67-564-025

1:2

Knochenchirurgie

Bone surgery



Knochenmeißel
Bone chisels and gouges
Ciseaux-burins, gouges
Cinceles, gubias
Scalpelli, sgorbi



SMITH-PETERSEN

	200 mm – 8"	200 mm – 8"	200 mm – 8"	200 mm – 8"
6 mm	67-570-006	67-571-006		
9 mm	67-570-009	67-571-009	67-574-009	67-575-009
13 mm	67-570-013	67-571-013		
14 mm			67-574-014	67-575-014
16 mm	67-570-016	67-571-016	67-574-016	67-575-016
19 mm	67-570-019	67-571-019	67-574-019	67-575-019
25 mm	67-570-025	67-571-025	67-574-025	67-575-025
32 mm	67-570-032	67-571-032		

1:2

Knochenmeißel

Bone chisels and gouges

Ciseaux-burins, gouges

Cinceles, gubias

Scalpelli, sgorbi



HIBBS

	240 mm – 9 ½"	240 mm – 9 ½"	240 mm – 9 ½"	240 mm – 9 ½"	240 mm – 9 ½"
6 mm	67-582-006	67-580-006	67-583-006	67-586-006	67-587-006
9 mm	67-582-009		67-583-009	67-586-009	67-587-009
13 mm	67-582-013	67-580-013	67-583-013	67-586-013	67-587-013
16 mm	67-582-016		67-583-016	67-586-016	67-587-016
19 mm	67-582-019	67-580-019	67-583-019	67-586-019	67-587-019
25 mm	67-582-025	67-580-025	67-583-025	67-586-025	67-587-025
32 mm	67-582-032	67-580-032	67-583-032	67-586-032	67-587-032

1:2



Knochenmeißel
Bone chisels and gouges
Ciseaux-burins, gouges
Cinceles, gubias
Scalpelli, sgorbi

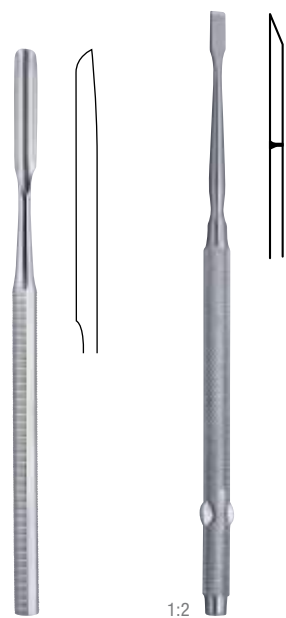

FREER

	150 mm – 6"	160 mm – 6 ¼"
6 mm	46-528-006	
4 mm		46-520-004

Hohlmeißel
 Gouge
 Gouge
 Gubia
 Sgorbi

Flachmeißel
 Chisel
 Ciseau burin
 Cincel
 Scalpello

BALLENGER

	160 mm – 6 ¼"
4 mm	346-480-040
6 mm	346-480-060
8 mm	346-480-080



1:2

**MANNERFELT
 MODIF.**

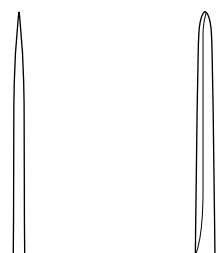

	155 mm – 6"	155 mm – 6"
3 mm		67-462-003
4 mm	67-460-004	
6 mm	67-460-006	
8 mm	67-460-008	

Osteotome
 Osteotomes
 Ostéotomes
 Osteótomos
 Osteotomi

Hohlmeißel
 Gouge
 Gouge
 Gubia
 Sgorbi

Meißel zur Nasenplastik

Chisels, osteotomes for rhinoplasty

Ostéotomes, ciseaux-burins pour rhinoplastique

Cinceles para rinoplastia

Scalpelli per plastica nasale



1:2

KILIAN

160 mm – 6 ¼"
5 mm
46-541-005



1:2

KILIAN-CLAUS

160 mm – 6 ¼"
5 mm
46-551-005

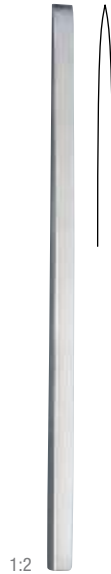

1:2

COTTLE

	150 mm – 6"
7 mm	46-570-007
9 mm	46-570-009
12 mm	46-570-012

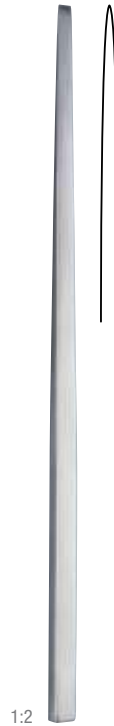

1:2

COTTLE

	190 mm – 7 ½"	180 mm – 7"
4 mm	46-574-004	
6 mm		46-577-006

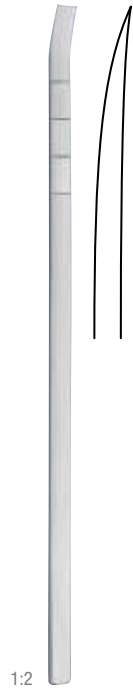

1:2



1:2

FOMON



1:1



1:1



1:1



1:1



1:1

	4 mm	5 mm	6 mm	7 mm	8 mm
170 mm – 6 ¾"	46-584-004	46-584-005	46-584-006	46-584-007	46-584-008

Knochenchirurgie

Bone surgery



09

Meißel zur Nasenplastik

Chisels, osteotomes for rhinoplasty

Ostéotomes, ciseaux-burins pour rhinoplastique

Cinceles para rinoplastia

Scalpelli per plastica nasale



1:2

CINELLI

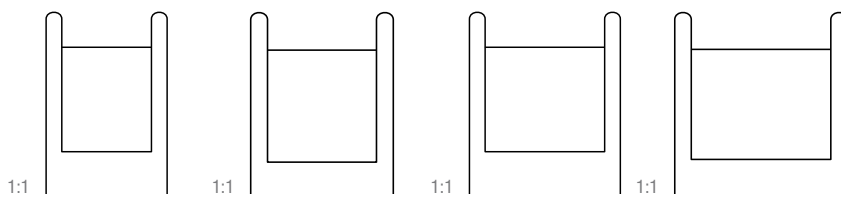

	10 mm	12 mm	14 mm	16 mm
180 mm – 7"	346-468-100	346-468-120	346-468-140	346-468-160



1:2

COTTLE

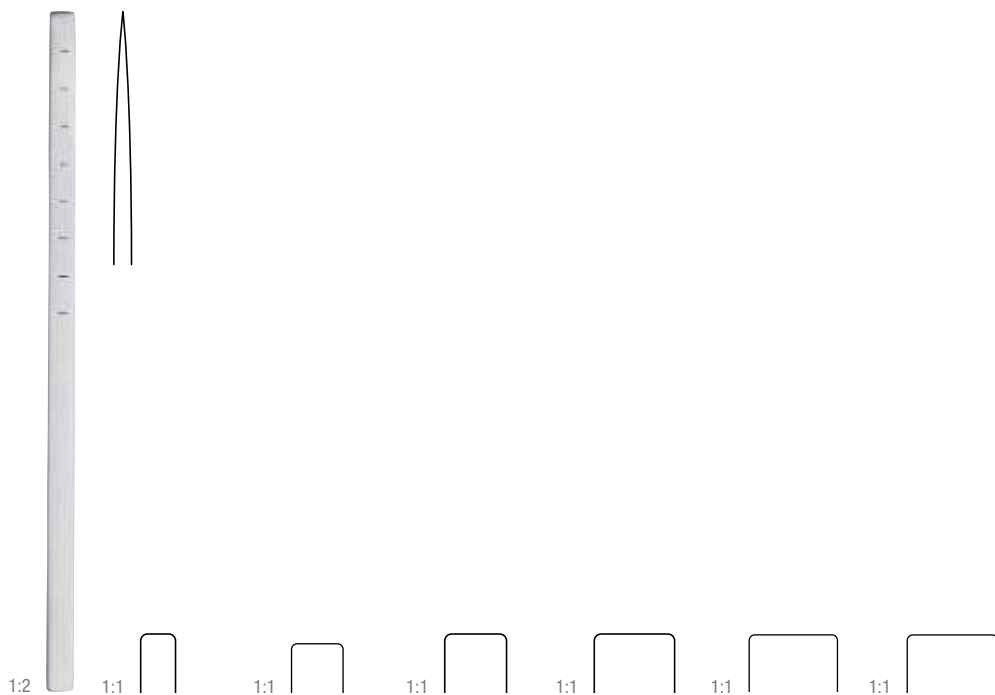

	4 mm	6 mm	7 mm	9 mm	10 mm	12 mm
180 mm – 7"	346-450-040	346-450-060	346-450-070	346-450-090	346-450-100	346-450-120

COTTLE



	4 mm	7 mm	9 mm	12 mm
180 mm – 7"	346-454-040	346-454-070	346-454-090	346-454-120

Meißel zur Nasenplastik

Chisels, osteotomes for rhinoplasty

Ostéotomes, ciseaux-burins pour rhinoplastique

Cinceles para rinoplastia

Scalpelli per plastica nasale

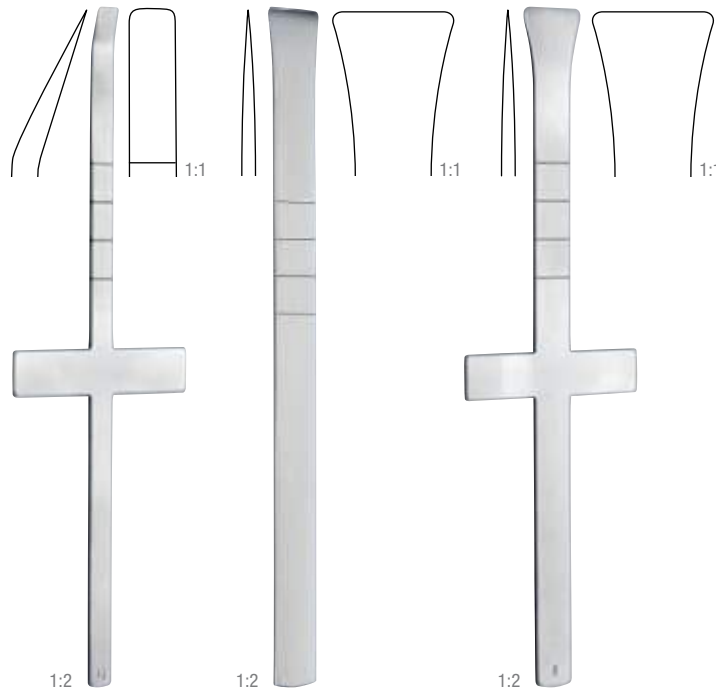

COTTLE

	6 mm	16 mm	16 mm
180 mm – 7"	437-605-060	437-606-160	437-608-160



RUBIN

	10 mm	12 mm	14 mm
180 mm – 7"	437-612-100	437-612-120	437-612-140



Meißel zur Nasenplastik

Chisels, osteotomes for rhinoplasty

Ostéotomes, ciseaux-burins pour rhinoplastique

Cinceles para rinoplastia

Scalpelli per plastica nasale



WALTER



	3 mm	4.5 mm
190 mm – 7 ½"	437-616-030	437-616-040

1:2



SHEEHAN

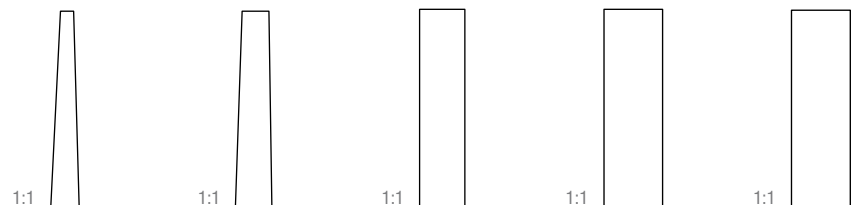

	2 mm	4 mm	6 mm	7 mm	8 mm
160 mm – 6 ¼"	437-622-020	437-622-040	437-622-060	437-622-070	437-622-080

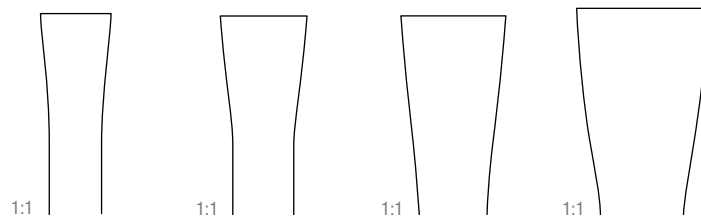

10 mm	12 mm	15 mm	18 mm
437-622-100	437-622-120	437-622-150	437-622-180

1:2

Meißel zur Nasenplastik

Chisels, osteotomes for rhinoplasty

Ostéotomes, ciseaux-burins pour rhinoplastique

Cinceles para rinoplastia

Scalpelli per plastica nasale



SILVER

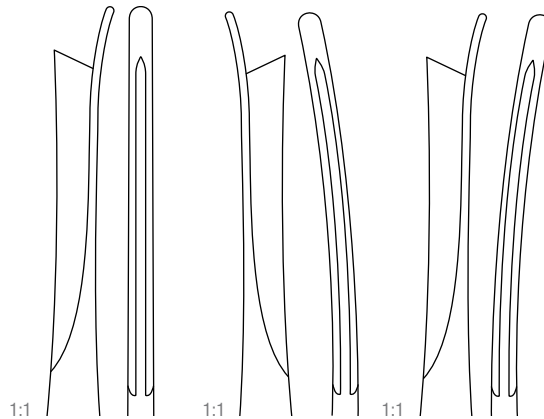

180 mm – 7"	346-469-010	346-469-020	346-469-030
gerade straight droit recta retta	rechts right droite derecha destra	links left gauche izquierda sinistra	



NEIVERT-ANDERSON

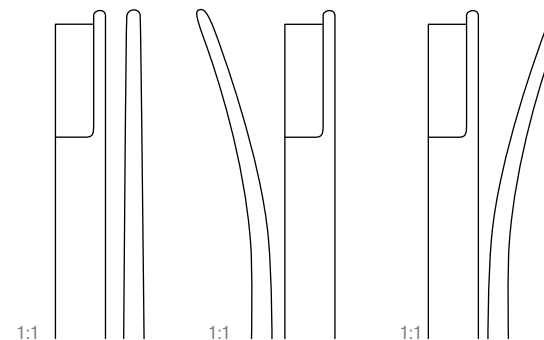

200 mm – 8"	346-471-010	346-471-020	346-471-030
gerade straight droit recta retta	rechts right droite derecha destra	links left gauche izquierda sinistra	



Meißel für die Kieferchirurgie

Osteotomes for maxillo-facial surgery

Ostéotomes pour la chirurgie maxillo-faciale

Cinceles para la cirugía maxilofacial

Scalpelli per chirurgia massilofaciale

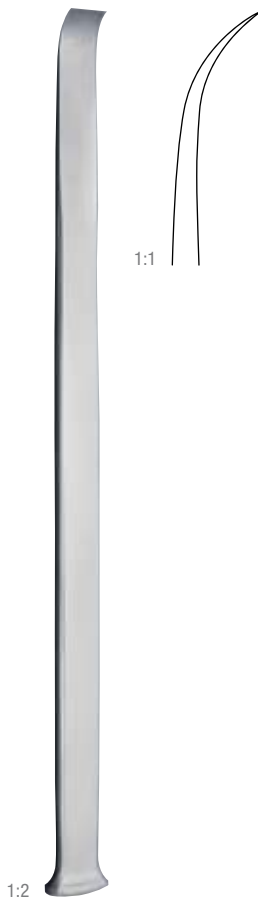

1:2

OBWEGESER

	8 mm	11 mm	13 mm
235 mm – 9¼"	348-622-080	348-622-110	348-622-240



1:2

1:2

OBWEGESER

	7 mm	10 mm
215 mm – 8½"	348-620-007	348-620-010

Stößel
Tampers
Pilons
Punzones
Pestoni



1:2

1:1 ○

1:1 ○

1:1 ○

1:1 ○

1:1 ○

1:1 ○

1:1 ○

	2 mm Ø	3 mm Ø	4 mm Ø	5 mm Ø	6 mm Ø	8 mm Ø	10 mm Ø
155 mm – 6"	332-578-020	332-578-030	332-578-040	332-578-050	332-578-060	332-578-080	332-578-100



1:2

PASSOW

1:1 □

1:1 □

1:1 □

	Fig. 1	Fig. 2	Fig. 3
	2.5 mm x 2.5 mm	3.5 mm x 3.5 mm	4.5 mm x 4.5 mm
120 mm – 4 ¾"	67-594-001	67-594-002	67-594-003



1:2



1:2

CASPAR

1:1 ●

1:1 ●

1:1 ●

	3 mm Ø	5 mm Ø	8 mm Ø
200 mm – 8"	332-580-030	332-580-050	332-580-080

1:1

1:1

1:1

	12 mm Ø	14 mm Ø	16 mm Ø
200 mm – 8"	332-582-120	332-582-140	332-582-160



Scharfe Löffel

Bone curettes

Curettes tranchantes
Cucharillas cortantes
Cucchiai taglienti



1:2

VOLKMANN



	Fig. 0000	Fig. 000	Fig. 00	Fig. 0	Fig. 1
170 mm – 6¾"	67-724-000	67-724-001	67-724-002	67-724-003	67-724-010

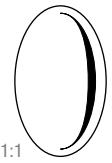
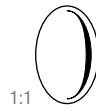

Fig. 2	Fig. 3	Fig. 4	Fig. 5	Fig. 6
67-724-020	67-724-030	67-724-040	67-724-050	67-724-060



1:2

SCHEDE



	Fig. 000	Fig. 00	Fig. 0	Fig. 1	Fig. 2
170 mm – 6¾"	67-720-001	67-720-002	67-720-003	67-720-010	67-720-020

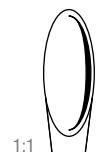

Fig. 3	Fig. 4
67-720-030	67-720-040

Scharfe Löffel
Bone curettes

Curettes tranchantes
Cucharillas cortantes
Cucchiai taglienti



SPRATT

1:1



1:1



1:1



	Fig. 0000	Fig. 000	Fig. 00
170 mm – 6 3/4"	67-732-004	67-732-001	67-732-002

1:1



1:1



1:1



Fig. 0	Fig. 1	Fig. 2
67-732-003	67-732-010	67-732-020

1:1



1:1



1:1



Fig. 3	Fig. 4	Fig. 5
67-732-030	67-732-040	67-732-050

1:2

BRUNS

1:1



1:1



1:1



	Fig. 000	Fig. 00	Fig. 0
160 mm – 6 1/4"	67-728-001	67-728-002	67-728-003

1:1



1:1



1:1



Fig. 1	Fig. 2	Fig. 3
67-728-010	67-728-020	67-728-030

1:1



1:1



1:1



Fig. 4	Fig. 5	Fig. 6
67-728-040	67-728-050	67-728-060

1:2



Scharfe Löffel
Bone curettes

Curettes tranchantes
Cucharillas cortantes
Cucchiai taglienti

VOLKMANN

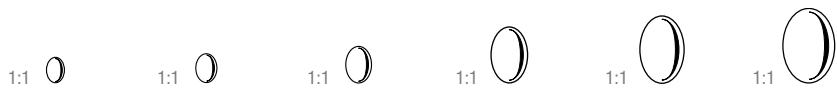

	Fig. 0000	Fig. 000	Fig. 00	Fig. 0	Fig. 1	Fig. 2
185 mm – 7 ¼"	423-276-400	423-276-300	423-276-200	423-276-100	423-276-010	423-276-020

oval, mit Kunststoffgriff
oval, with plastic handle
ovale, avec manche en matière plastique
ovalada, con mango plástico
ovale, con manico in plastica



	Fig. 3	Fig. 4	Fig. 5	Fig. 6
190 mm – 7 ½"	423-276-030	423-276-040	423-276-050	423-276-060



	Fig. 0	Fig. 1	Fig. 2	Fig. 3	Fig. 4
275 mm – 10 ¾"	423-278-100	423-278-010	423-278-020	423-278-030	423-278-040

Scharfe Löffel
Bone curettes

Curettes tranchantes
Cucharillas cortantes
Cucchiai taglienti



1:2

HALLE

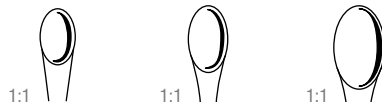

	Fig. 1	Fig. 2	Fig. 3
210 mm – 8 ¼"	67-750-010	67-750-020	67-750-030

flexibel
flexible
flexible
flexible
flessibile



UFFENORDE

	Fig. 1	Fig. 2
170 mm – 6 ¾"	382-837-001	382-837-002



Scharfe Löffel
Bone curettes

Curettes tranchantes
Cucharillas cortantes
Cucchiai taglienti

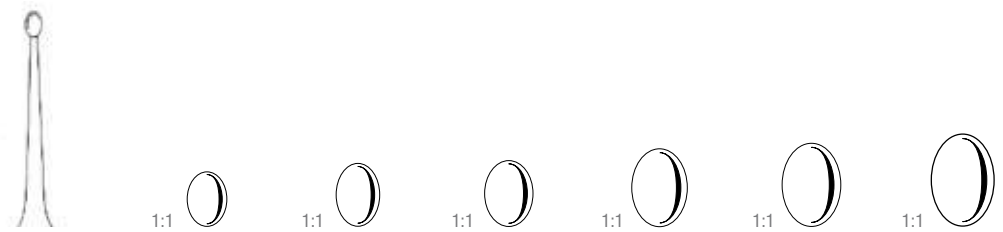

	Fig. 1	Fig. 2	Fig. 3	Fig. 4	Fig. 5	Fig. 6
160 mm – 6 1/4"	382-840-010	382-840-020	382-840-030	382-840-040	382-840-050	382-840-060

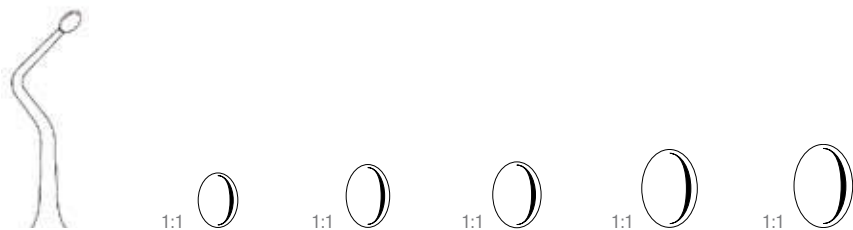

	Fig. 1	Fig. 2	Fig. 3	Fig. 4	Fig. 5
160 mm – 6 1/4"	382-843-010	382-843-020	382-843-030	382-843-040	382-843-060

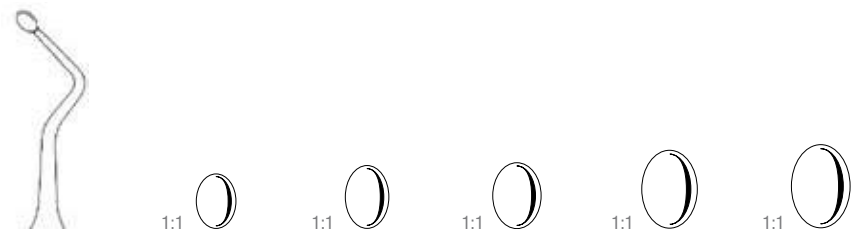

	Fig. 1	Fig. 2	Fig. 3	Fig. 4	Fig. 5
160 mm – 6 1/4"	382-841-010	382-841-020	382-841-030	382-841-040	382-841-060

Scharfe Löffel
Bone curettes

Curettes tranchantes
Cucharillas cortantes
Cucchiai taglienti

BRUNS



		Fig. 00	Fig. 0	Fig. 1	Fig. 2
230 mm – 9"	gerade straight droit recta retto	67-738-002	67-738-003	67-738-010	67-738-020
230 mm – 9"	gebogen curved courbe curva curvo	67-739-002	67-739-003	67-739-010	67-739-020

massiv
solid
solide
macizo
massiccio



1:2

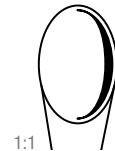

		Fig. 3	Fig. 4	Fig. 5	Fig. 6
230 mm – 9"	gerade straight droit recta retto	67-738-030	67-738-040	67-738-050	67-738-060
230 mm – 9"	gebogen curved courbe curva curvo	67-739-030	67-739-040	67-739-050	67-739-060

massiv
solid
solide
macizo
massiccio



Scharfe Löffel
Bone curettes

Curettes tranchantes
Cucharillas cortantes
Cucchiai taglienti



1:2

SCHROEDER

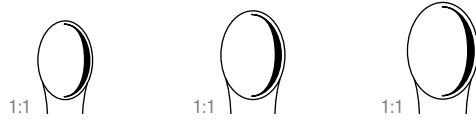

	Fig. 1	Fig. 2	Fig. 3
300 mm – 12"	62-612-001	62-612-002	62-612-003

scharf / fest
sharp / rigid
tranchante / rigide
cortante / rigida
tagliente / rigido

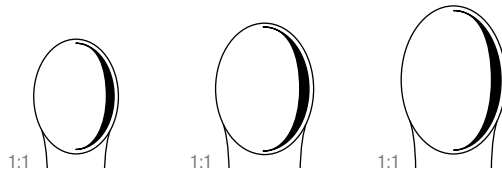

Fig. 4	Fig. 5	Fig. 6
62-612-004	62-612-005	62-612-006

SIMON



	Fig. 1	Fig. 2	Fig. 3	Fig. 4	Fig. 5	Fig. 6
240 mm – 9½"	67-744-010	67-744-020	67-744-030	67-744-040	67-744-050	67-744-060

scharf / fest
sharp / rigid
tranchante / rigide
cortante / rigida
tagliente / rigido



1:2

SIMON

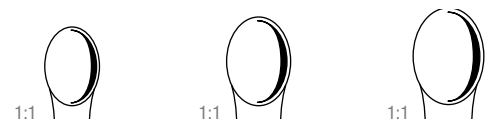

	Fig. 1	Fig. 2	Fig. 3
250 mm – 9¾"	62-610-001	62-610-002	62-610-003

scharf / fest
sharp / rigid
tranchante / rigide
cortante / rigida
tagliente / rigido

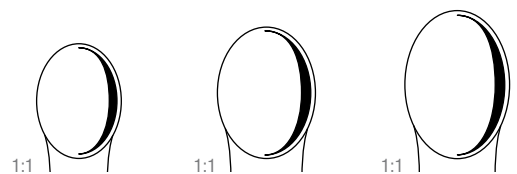





Fig. 4	Fig. 5	Fig. 6
62-610-004	62-610-005	62-610-006

Scharfe Löffel
Bone curettes





Curettes tranchantes
Cucharillas cortantes
Cucchiai taglienti



1:2

				
	1:1	1:1	1:1	1:1
	Fig. 000	Fig. 00	Fig. 0	Fig. 1
	3.6 mm	4.4 mm	5.2 mm	6.8 mm
250 mm – 9¾"	332-506-360	332-506-440	332-506-520	332-506-600





gerade
straight
droit
recta
retto

				
1:1	1:1	1:1	1:1	
	Fig. 000	Fig. 00	Fig. 0	Fig. 1
	3.6 mm	4.4 mm	5.2 mm	6.8 mm
250 mm – 9¾"	332-507-360	332-507-440	332-507-520	332-507-600

gebogen
curved
courbe
curva
curvo



1:2

				
	1:1	1:1	1:1	1:1
DAUBENSPECK	Fig. 00	Fig. 0	Fig. 1	Fig. 2
	2.8 mm	3.6 mm	4.4 mm	5.2 mm
200 mm – 8"	332-482-990	332-483-000	332-483-010	332-483-020



Scharfe Löffel
Bone curettes

Curettes tranchantes
Cucharillas cortantes
Cucchiai taglienti



1:2
SCOVILLE



	Fig. 1	Fig. 2	Fig. 3
250 mm – 9¾"	382-822-250	382-833-250	382-835-250

oval
 oval
 ovale
 ovalada
 ovale

1:2
LEMPERT

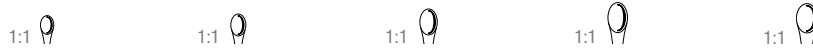
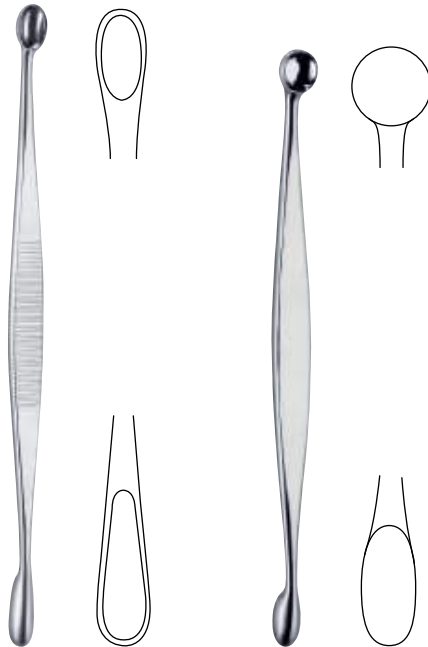

	Fig. 00000	Fig. 0000	Fig. 000	Fig. 00	Fig. 0
	1.8 mm	2.0 mm	2.4 mm	2.6 mm	2.8 mm
215 mm – 8½"	332-486-500	332-486-400	332-486-300	332-486-200	332-486-100

Scharfe Doppellöffel
Bone curettes, double-ended
Curettes doubles
Cucharillas de doble extremo
Curette doppia



VOLKMANN

130 mm – 5"	67-770-130	67-774-130
140 mm – 5½"	67-770-140	
160 mm – 6¼"		67-774-160
170 mm – 6¾"	67-770-170	
200 mm – 8"		67-774-200

oval / oval
oval / oval
ovale / ovale
ovalada / ovalada
ovale / ovale

rund / oval
round / oval
ronde / ovale
redonda / ovalada
rotondo / ovale

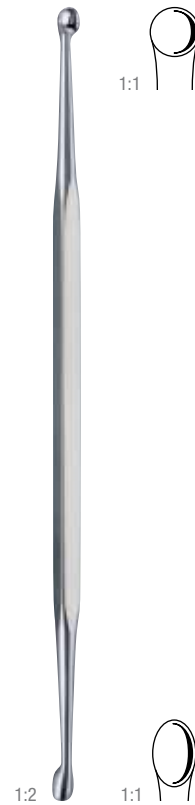

210 mm – 8¼"	332-498-210
--------------	-------------

rund / oval
round / oval
ronde / ovale
redonda / ovalada
rotondo / ovale



Scharfe Doppellöffel
Bone curettes, double-ended
Curettes doubles
Cucharillas de doble extremo
Curette doppia



MARTINI



	Fig. 00	Fig. 0	Fig. 1
	Fig. 0	Fig. 1	Fig. 2
135 mm – 5 ¼"	67-794-000	67-794-001	67-794-012



MARTINI



	Fig. 00	Fig. 0	Fig. 1
	Fig. 0	Fig. 1	Fig. 2
155 mm – 6"	382-859-000	382-859-100	382-859-110



WILLIGER

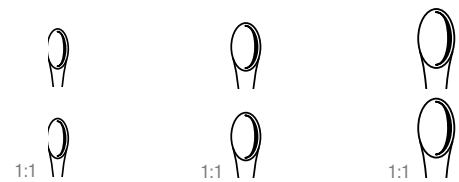

	Fig. 00	Fig. 0	Fig. 1
	Fig. 0	Fig. 1	Fig. 2
135 mm – 5 ¼"	67-790-000	67-790-001	67-790-012



WILLIGER



	Fig. 00	Fig. 0	Fig. 1
	Fig. 0	Fig. 1	Fig. 2
155 mm – 6"	382-855-000	382-855-100	382-855-110

Raspatorien für die Kieferchirurgie

Periosteal elevators for maxillo-facial surgery

Rugines – Décolleurs pour la chirurgie maxillo-faciale

Periostótomos para la cirugía máxilofacial

Raspari per chirurgia massilofaciale

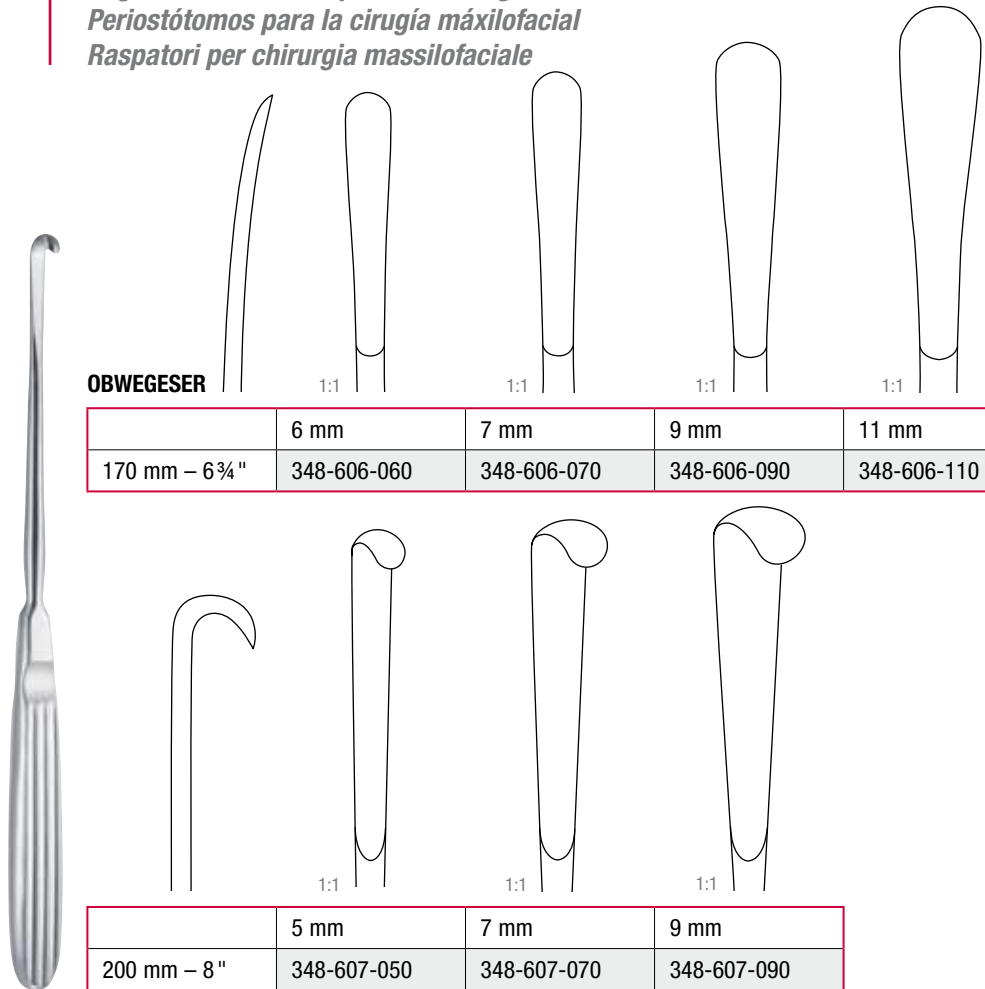

OBWEGESER

	6 mm	7 mm	9 mm	11 mm
170 mm – 6 3/4"	348-606-060	348-606-070	348-606-090	348-606-110

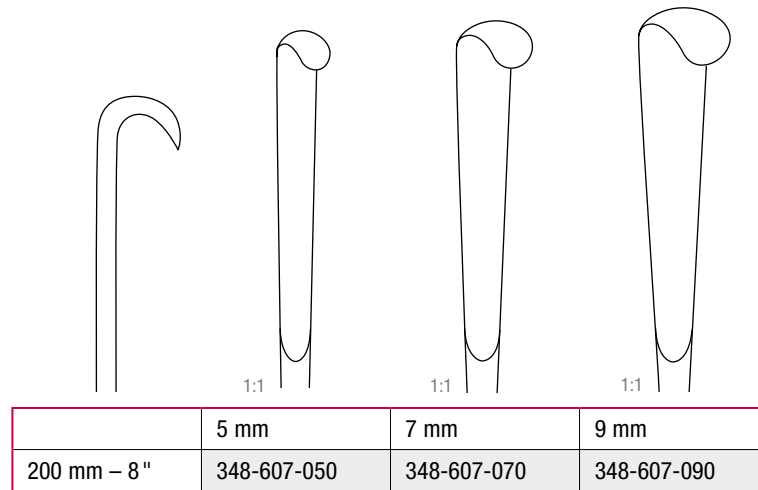

	5 mm	7 mm	9 mm
200 mm – 8"	348-607-050	348-607-070	348-607-090



OBWEGESER-FREER

210 mm – 8 1/4"	348-610-210
-----------------	-------------



OBWEGESER-FREER

210 mm – 8 1/4"	348-612-210
-----------------	-------------



Raspatorien und Ahlen für die Kieferchirurgie

Periosteal elevators and awls for maxillo-facial surgery

Rugines, décolleurs et passe-fils pour chirurgie maxillo-faciale

Periostótomos y leznas para la cirugía máxilofacial

Raspatori, punteruoli per chirurgia massilofaciale

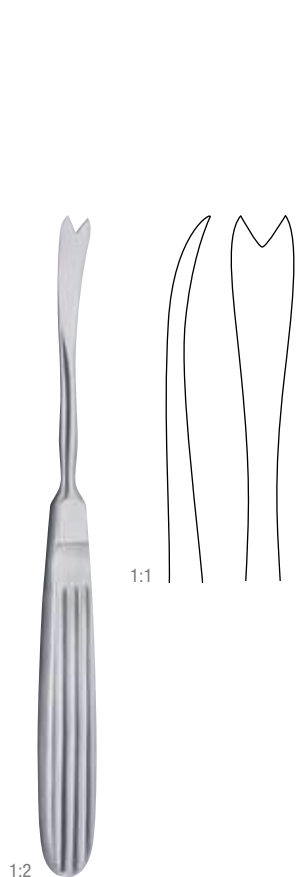

1:2

OBWEGESER

175 mm – 7"	348-608-020
-------------	-------------



1:1

1:2

OBWEGESER

230 mm – 9"	348-675-230
-------------	-------------



1:1

OBWEGESER

180 mm – 7"	22-210-180
230 mm – 9"	22-210-230
280 mm – 11"	22-210-280



1:1

1:2

OBWEGESER

130 mm – 5"	22-220-130
-------------	------------

Raspatorien – Elevatorien
Periosteal raspatories – Elevators

Rugines – Elévateurs
Raspatorios – Elevadores
Periostotomi – Elevatori



DOYEN

170 mm – 6 ¾"	27-755-170	27-751-170
240 mm – 9 ½"	27-755-240	

links
left
gauche
izquierda
sinistra

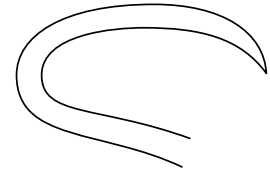
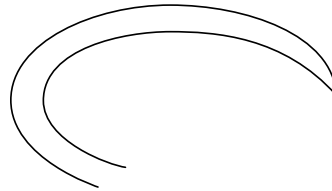

für Erwachsene
for adults
pour adultes
para adultos
per adulti

für Kinder
for children
pour enfants
para niños
per bambini



DOYEN

170 mm – 6 ¾"	27-757-170	27-753-170
240 mm – 9 ½"	27-757-240	

rechts
right
droite
derecha
destra

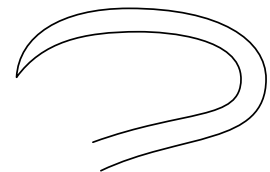
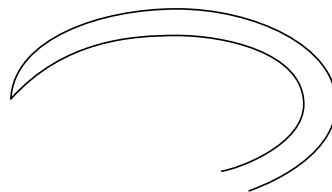

für Erwachsene
for adults
pour adultes
para adultos
per adulti

für Kinder
for children
pour enfants
para niños
per bambini



Raspatorien – Elevatorien
Periosteal raspatories – Elevators
Rugines – Elévateurs
Raspatorios – Elevadores
Periostotomi – Elevatori

QUERVAIN 1:2 1:1 1:1

	x = 6 mm
195 mm – 7¾"	332-746-200

TRELAT 1:2 1:1 1:1

	x = 8 mm
150 mm – 6"	423-445-140

KÖNIG 1:2 1:1 1:1

	x = 4.5 mm	x = 4.5 mm
155 mm – 6"	332-812-150	332-813-150

Raspatorien – Elevatorien
Periosteal raspatories – Elevators

Rugines – Elévateurs
Raspatorios – Elevadores
Periostotomi – Elevatori

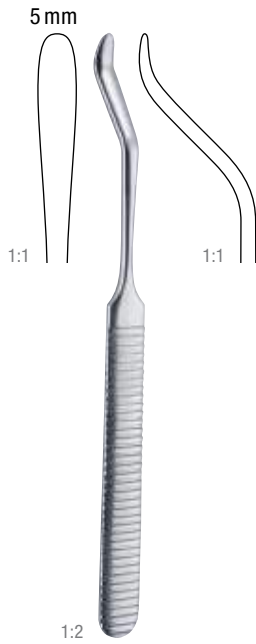

160 mm – 6¼"	423-519-160
--------------	-------------

ALDERDYCE

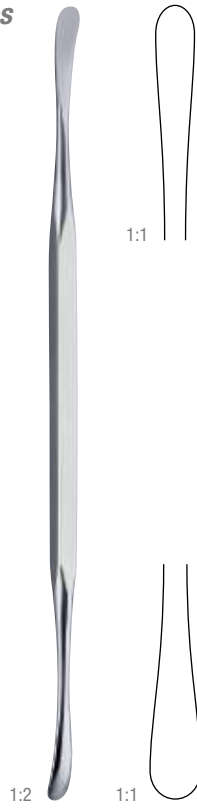

210 mm – 8¼"	423-521-210
--------------	-------------

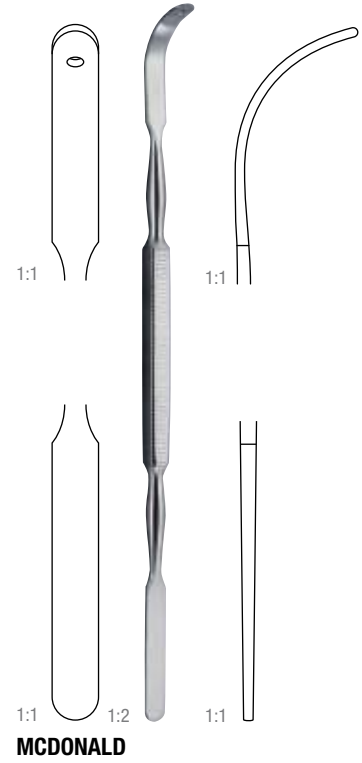

MCDONALD

190 mm – 7½"	332-763-190
--------------	-------------



SEDILLOT

185 mm – 7¼"	332-704-185
210 mm – 8¼"	332-705-210

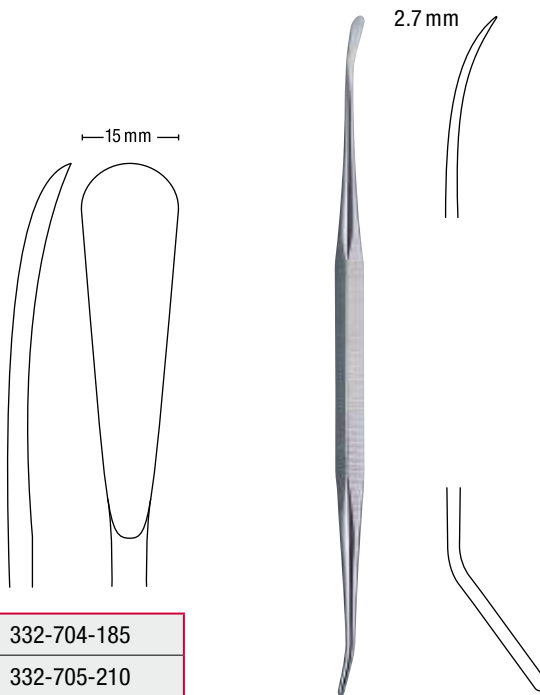

WATSON-CHEYNE

130 mm – 5⅛"	332-762-130
190 mm – 7½"	332-762-190



Raspatorien – Elevatorien

Periosteal raspatories – Elevators

Rugines – Elévateurs
 Raspatorios – Elevadores
 Periostotomi – Elevatori

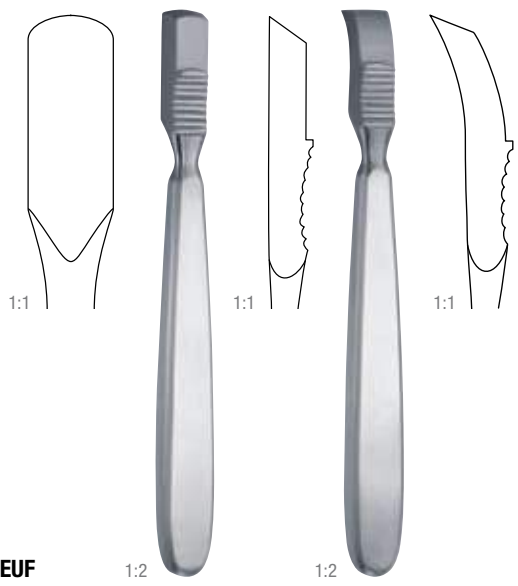

FARABEU

150 mm – 6"	27-720-150	27-721-150
-------------	------------	------------

gerade
 straight
 droit
 recta
 retto

gebogen
 curved
 courbe
 curva
 curvo

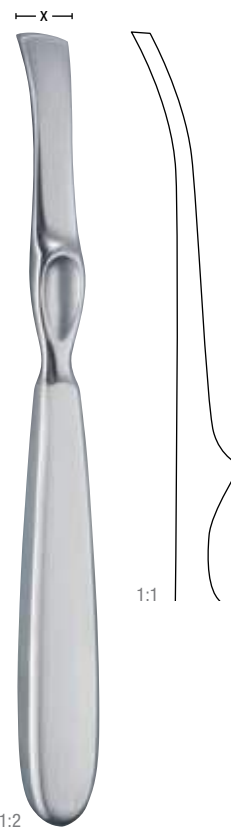

LAMBOTTE

	210 mm – 8 ¼"
x = 5 mm	332-701-050
x = 10 mm	332-701-100
x = 15 mm	332-701-150
x = 20 mm	332-701-200
x = 25 mm	332-701-250



ADSON

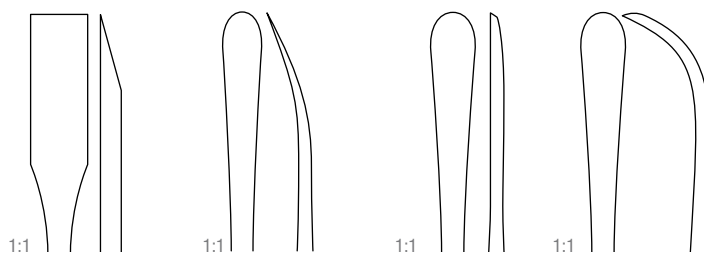
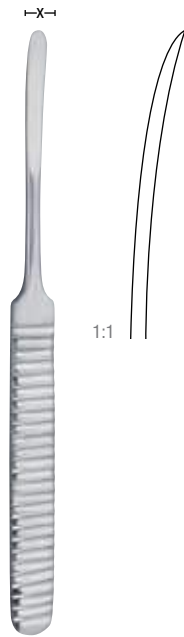

	Fig. 1	Fig. 2	Fig. 3	Fig. 4
170 mm – 6 ¾"	332-750-170	332-751-170	332-752-170	332-753-170

Raspatorien – Elevatorien
Periosteal raspatories – Elevators

Rugines – Elévateurs
Raspatorios – Elevadores
Periostotomi – Elevatori



WILLIGER

1:2

	160 mm – 6 ¼"
x = 4 mm	27-741-160
x = 5 mm	27-742-160

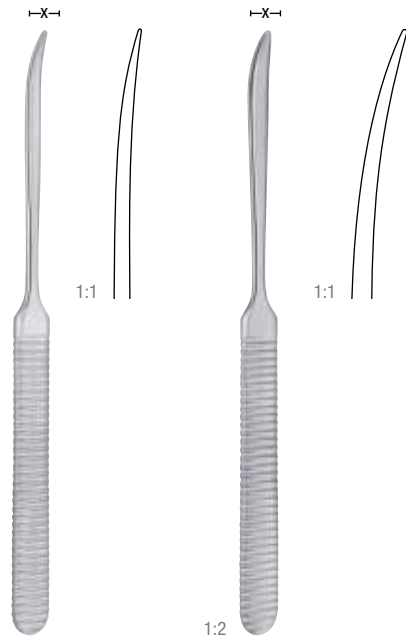

WILLIGER

1:2

1:2

	x = 5 mm	x = 6.5 mm
160 mm – 6 ¼"	27-243-160	27-241-170



WILLIGER

1:2

	x = 5 mm
130 mm – 5"	382-890-130

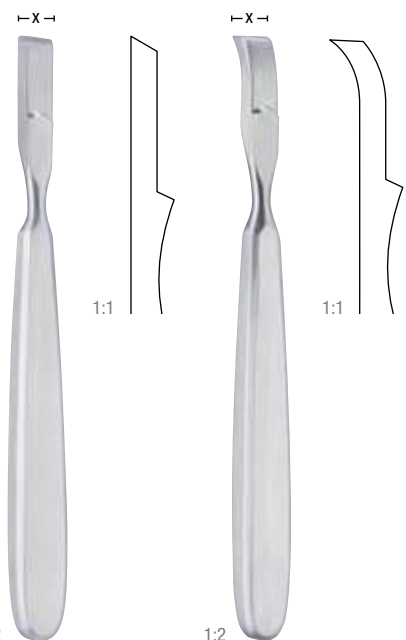

**FARABEUF-
COLLIN**

1:2

1:2

	x = 11 mm	x = 11 mm
160 mm – 6 ¼"	332-698-160	332-699-160



Raspatorien – Elevatorien
Periosteal raspatories – Elevators
Rugines – Elévateurs
Raspatorios – Elevadores
Periostotomi – Elevatori



OBWEGESER 1:2
 185 mm – 7 ¼" 348-626-190



OBWEGESER 1:2
 185 mm – 7 ¼" 348-628-190



OBWEGESER



1:1



1:1



1:1

	2.5 mm	4 mm	6.5 mm
150 mm – 6"	348-616-020	348-616-040	348-616-060

Raspatorien – Elevatorien
Periosteal raspatories – Elevators
Rugines – Elévateurs
Raspatorios – Elevadores
Periostotomi – Elevatori



SEMB	1:2	1:2	1:2	1:2	1:2	1:2
175 mm – 7"	210 mm – 8¼"	175 mm – 7"	210 mm – 8¼"	225 mm – 8¾"	220 mm – 8¾"	
12 mm	12 mm	13 mm	13 mm	13 mm	15 mm	
332-725-010	332-725-020	332-725-030	332-725-040	332-725-050	332-725-090	



Raspatorien – Elevatorien

Periosteal raspatories – Elevators

Rugines – Elévateurs
Raspatorios – Elevadores
Periostotomi – Elevatori

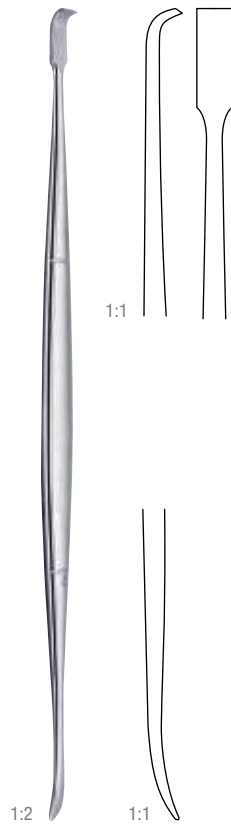

HOWARTH

215 mm – 8½"	437-577-210
--------------	-------------

scharf / stumpf
 sharp / blunt
 pointu / mousse
 aguda / roma
 acuta / smussa

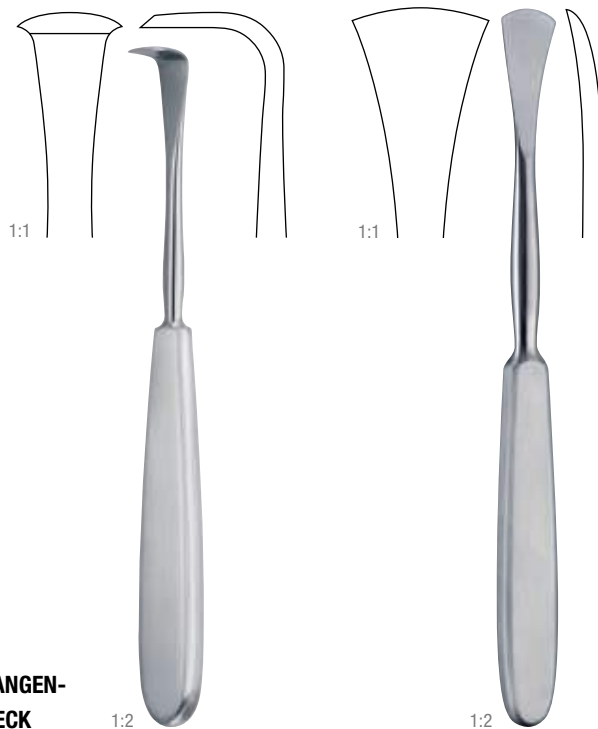

LANGENBECK

180 mm – 7"	190 mm – 7½"
332-707-180	27-731-190

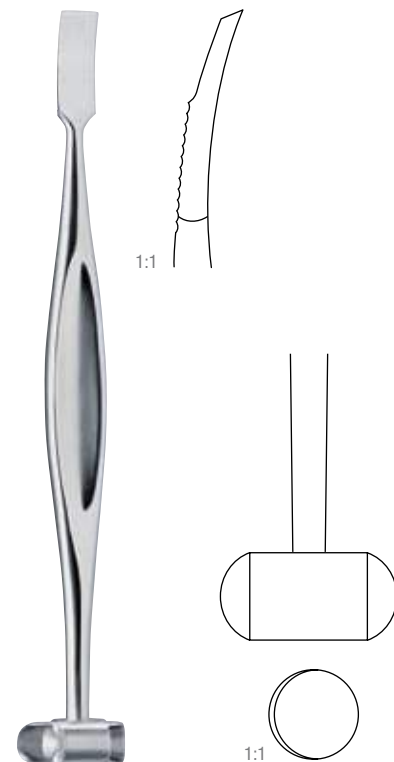

ALEXANDER

160 mm – 6¼"	332-711-160
200 mm – 8"	332-711-200

Raspatorien – Elevatorien
Periosteal raspatories – Elevators

Rugines – Elévateurs
Raspatorios – Elevadores
Periostotomi – Elevatori



LANGENBECK

	x = 8 mm	x = 10 mm
200 mm – 8"	27-221-200	27-223-200



175 mm – 7"	423-510-170
-------------	-------------

extrem leicht
extremely light
extrêmement léger
extremadamente ligero
estremamente leggera

SEBILEAU

	x = 5 mm
175 mm – 7"	332-744-170



Raspatorien – Elevatorien

Periosteal raspatories – Elevators

Rugines – Elévateurs
 Raspatorios – Elevadores
 Periostotomi – Elevatori



COBB 1:2

	290 mm – 11 ½"
x = 8 mm	332-496-008
x = 10 mm	332-496-010
x = 12 mm	332-496-012
x = 13 mm	332-496-013
x = 19 mm	332-496-019
x = 25 mm	332-496-025

Wirbelsäulen-Raspatorium
 Spinal raspatory
 Rugine vertebrale
 Raspador vertebral
 Periostotomo vertebrale



KEY

1:1	1:1	1:1
180 mm – 7"	190 mm – 7 ½"	190 mm – 7 ½"
x = 6 mm	x = 9 mm	x = 12 mm
332-755-060	332-755-090	332-755-120

1:1	1:1
200 mm – 8"	210 mm – 8 ¼"
x = 19 mm	x = 25 mm
332-755-190	332-755-250

Raspatorien
Periosteal raspatories

Rugines
Raspatorios
Periostotomi



1:2

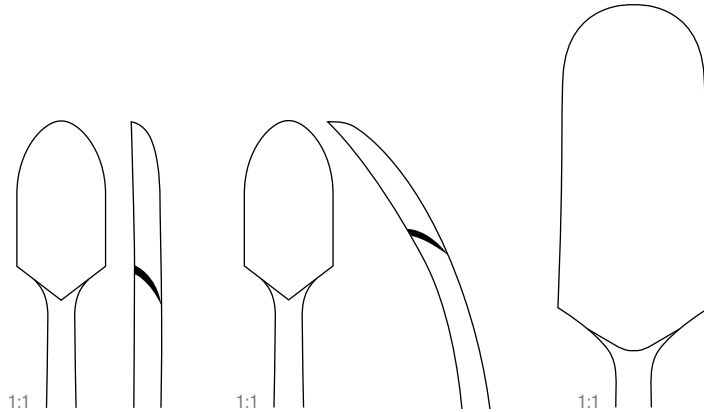

	Fig. 1	Fig. 2	Fig. 3
	14 mm	14 mm	20 mm
200 mm – 8"	332-770-140	332-771-140	423-433-200

Ferrozellgriff
Ferrozell handle
Manche en Ferrozell
Mango en Ferrozell
Manico di Ferrozell

gerade
straight
droit
recta
retto

gebogen
curved
courbe
curva
curvo

gerade
straight
droit
recta
retto



1:2

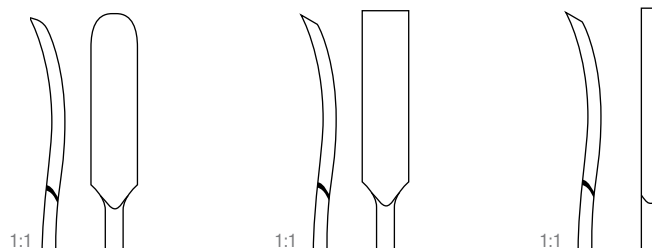

	Fig. 1	Fig. 2	Fig. 3
	6 mm	3 mm	6 mm
180 mm – 7"	332-777-060	332-775-060	332-779-030

Ferrozellgriff
Ferrozell handle
Manche en Ferrozell
Mango en Ferrozell
Manico di Ferrozell

Knochenchirurgie

Bone surgery



09

Knochenheber Bone levers

Leviers à os
Elevadores para huesos
Elevatori per ossa



HOHMANN

220 mm – 8 ¾"	240 mm – 9 ½"	240 mm – 9 ½"	240 mm – 9 ½"
x = 8 mm	x = 18 mm	x = 43 mm	x = 70 mm
67-825-008	67-825-018	67-825-043	67-825-070

Knochenhebel
Bone levers

Leviers à os
Elevadores para huesos
Elevatori per ossa



HOHMANN

245 mm – 9¾"	260 mm – 10¼"	280 mm – 11"	265 mm – 10½"	260 mm – 10¼"
x = 43 mm	x = 22 mm	x = 33 mm	x = 24 mm	x = 22 mm
67-829-043	67-829-022	67-829-033	332-803-240	332-805-220

Knochenchirurgie

Bone surgery



09

Knochenheber

Bone levers

Leviers à os

Elevadores para huesos

Elevatori per ossa



1:2

MINI-HOHMANN

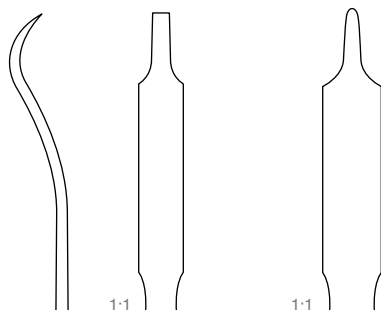

	6 mm	8 mm
160 mm – 6 ¼"	67-821-006	67-821-008



1:2

BRISTOW

230 mm – 9"	332-833-230
-------------	-------------



1:2

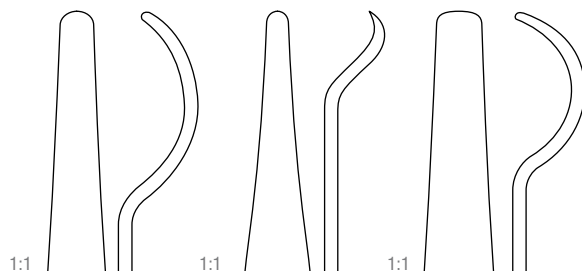

	2.8 mm	4.5 mm	6 mm
140 mm – 5 ½"	332-811-050	332-811-060	332-811-065



1:2

LANE

210 mm – 8 ¼"	332-831-270
---------------	-------------

Knochenhebel

Bone levers

Leviers à os

Elevadores para huesos

Elevatori per ossa



BENNETT

1:2

	240 mm – 9½"
x = 43 mm	67-851-240
x = 60 mm	332-767-710

← 30 mm →



MURPHY-LANE

1:2

← 18 mm →

340 mm – 13½"	332-765-300
---------------	-------------

Luxationshebel

Luxation lever

Levier de luxation

Palanca de luxación

Leva per luxazione

Knochenchirurgie

Bone surgery



Knochenheber

Bone levers

Leviers à os
 Elevadores para huesos
 Elevatori per ossa



BLOUNT

1:2

1:2

260 mm – 10¼"	332-819-260	332-821-260
---------------	-------------	-------------



**LANGE-
HOHMANN MOD.**

265 mm – 10½"	280 mm – 11"
x = 30 mm	x = 33 mm
332-789-300	332-789-340

Knochenhebel
Bone levers

Leviers à os
Elevadores para huesos
Elevatori per ossa

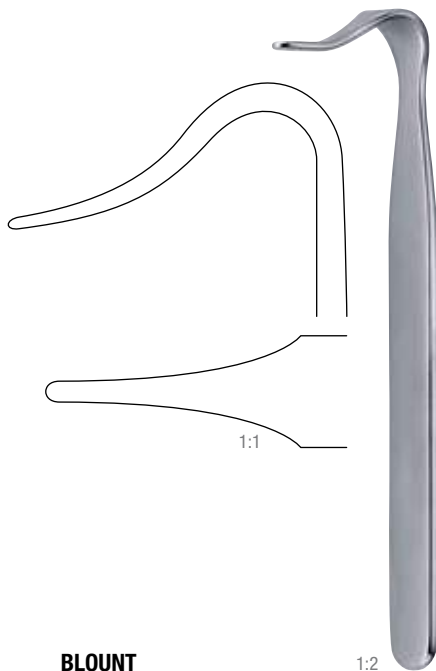

BLOUNT

1:2

175 mm – 7"	332-823-170
-------------	-------------



TAYLOR

	165 mm – 6½"
a = 75 mm – b = 30 mm	332-827-160
a = 100 mm – b = 30 mm	332-829-160



Meniskotome

Meniscotomy knives

Bistouries à ménisques

Bisturías para meniscós

Bisturi per menisco



BIRCHER

1:2

190 mm – 7 ½"

02-821-190

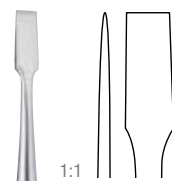

1:1



1:1



1:1



1:2



1:2



1:2

SMILLIE

170 mm – 6 ¾"

02-870-001

02-870-002

02-870-003

Meniskotome

Meniscotomy knives

Bistouries à ménisques

Bisturías para meniscós

Bisturi per menisco

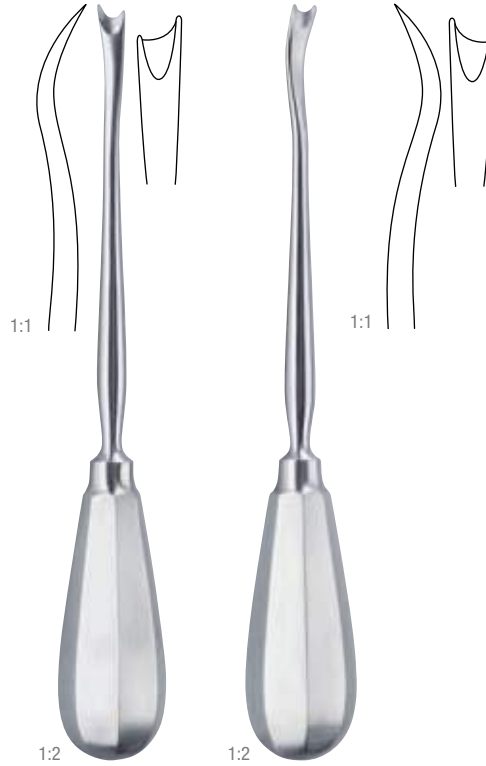

**CANAD.
MODELL**

	Fig. 1	Fig. 2
200 mm – 8"	02-847-200	02-849-200

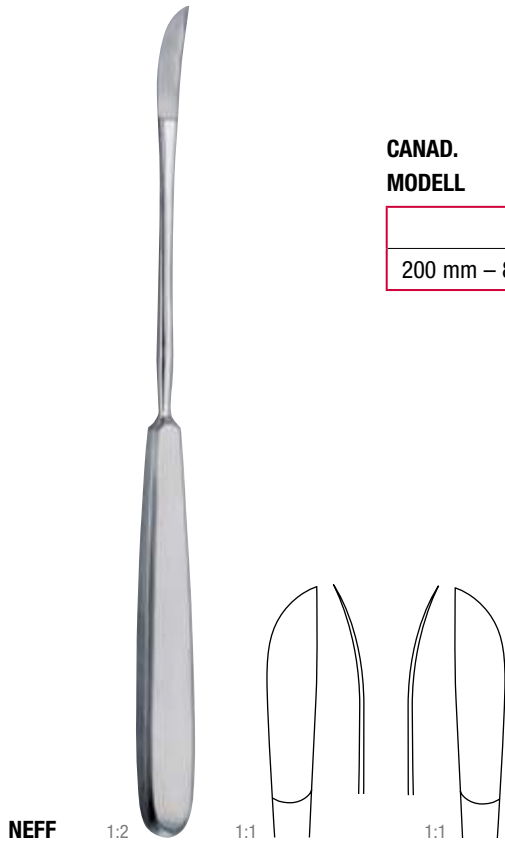

NEFF

220 mm – 8 3/4"

02-831-220

02-833-220

links
Ivra

rechts
right
droite
derecha
destra

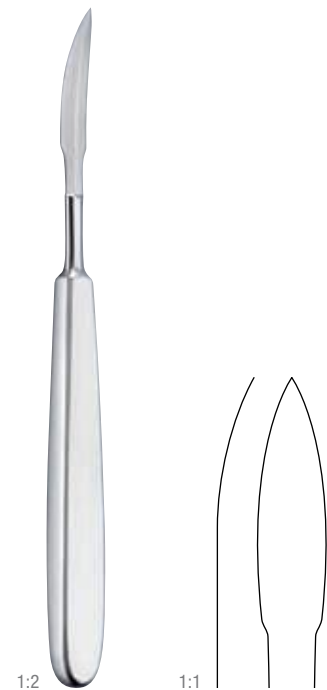

180 mm – 7"

02-837-175





Sehnenstripper

Tendon strippers

Instruments à écorcher les tendons
Enucleadores de tendones
Scollatendini



1:2



	1:1 	1:1 	1:1 
	4.0 mm Ø	4.5 mm Ø	5.5 mm Ø
230 mm – 9"	423-650-400	423-650-450	423-650-550



Schaft biegsam
 Malleable shaft
 Tige malléable
 Flecha maleable
 Asta malleabile



1:2

BUNNELL

	1:1 	1:1 	1:1 
	Fig. 1	Fig. 2	Fig. 3
150 mm – 6"	67-920-001	67-920-002	67-920-003

	1:1 	1:1 
	Fig. 4	Fig. 5
67-920-004	67-920-005	

Sehnenstripper
Tendon strippers

Instruments à écorcher les tendons
Enucleadores de tendones
Scollatendini



FISCHER

1:2

310 mm – 12 ¼"	423-656-310
----------------	-------------



BUNNELL

1:2

230 mm – 9"
67-934-230

**Sehnedurchzugs-
sonde**
Tendon passer
Sonde conductrice pour tendons
Sonda conductora de tendones
Sonda conduttrice per tendini



1:2

**KLEINERT-
KUTZ**

200 mm – 8"
20 mm Ø
423-677-200



Sehnenfazzangen

Tendon holding forceps

Pinces pour saisir les tendons

Pinzas para coger tendones

Pinze per afferrare tendini



BRAND

1:1



1:1



1:1



150 mm – 6 "	190 mm – 7 1/2 "	240 mm – 9 1/2 "
67-951-150	67-951-190	67-951-240



1:2

1:1

130 mm – 5 "

423-676-130



1:2

1:1

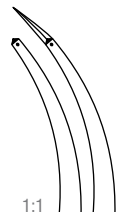

1:1

150 mm – 6 "

423-678-150

423-679-150