



Nervenhaken

Nerve hooks

Crochets à nerfs

Ganchos para nervios

Uncini per nervi



SCOVILLE

1:2

230 mm – 9"
x = 8 mm
424-720-230

HOLSHER

1:2

240 mm – 9½"
x = 7 mm
424-721-240

SCOVILLE

1:2

200 mm – 8"
x = 7 mm
424-723-190

1:2

210 mm – 8¼"
x = 7 mm
424-725-190

Duramesser
Dura knives

Bistouries pour duremère
Bisturis para duramadre
Bisturi per duramadre



1:1



1:1



TOENNIS

150 mm – 6"	190 mm – 7 ½"
02-164-130	02-164-190



1:2



1:1

HALLE

200 mm – 8"	02-168-200
-------------	------------



Nervenhaken – Durahaken

Nerve hooks – Dura hooks

Crochets à nerfs – Crochets pour duremère

Ganchos para nervios – Ganchos para duramadre

Uncini per nervi – Uncini per duramadre



SMITHWICK

1:1

170 mm – 6¾"	424-744-170
210 mm – 8¼"	424-744-210



HOEN

1:2

1:1

220 mm – 8¾"
424-751-220

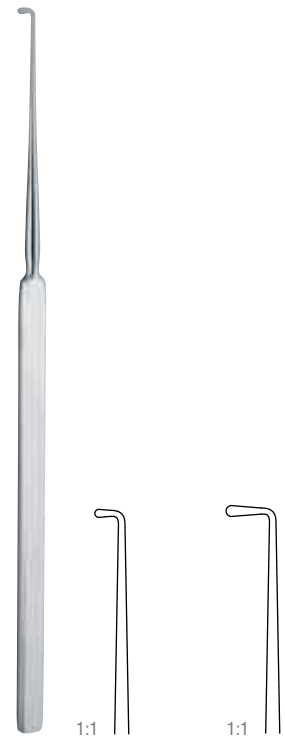

CUSHING

1:1

1:1

190 mm – 7½"	24-481-190	24-483-190
280 mm – 11"	340-052-280	340-054-280

Nervenhaken – Durahaken
Nerve hooks – Dura hooks

Crochets à nerfs – Crochets pour duremère
Ganchos para nervios – Ganchos para duramadre
Uncini per nervi – Uncini per duramadre

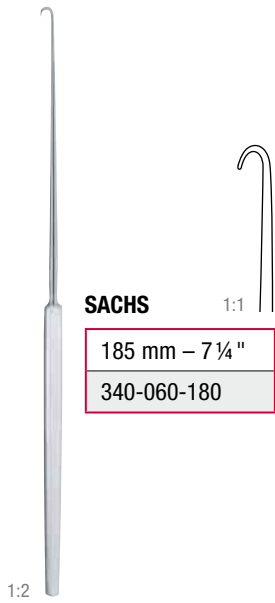

SACHS 1:1
185 mm – 7 ¼"
340-060-180

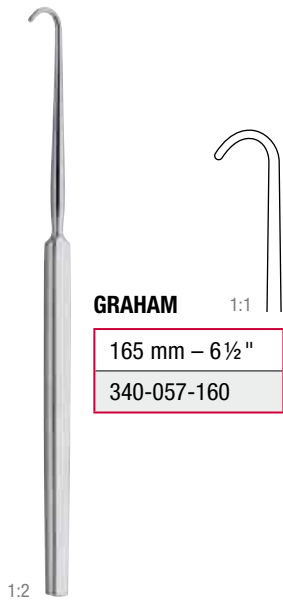

GRAHAM 1:1
165 mm – 6 ½"
340-057-160

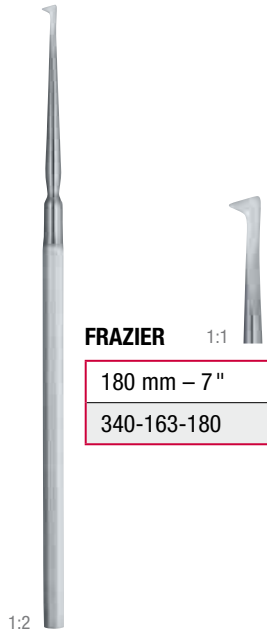

FRAZIER 1:1
180 mm – 7"
340-163-180

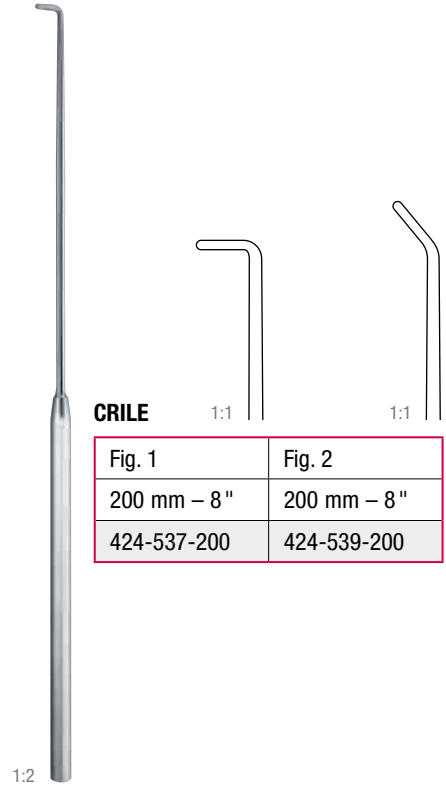

CRILE 1:1 1:1
Fig. 1 Fig. 2
200 mm – 8" 200 mm – 8"
424-537-200 424-539-200

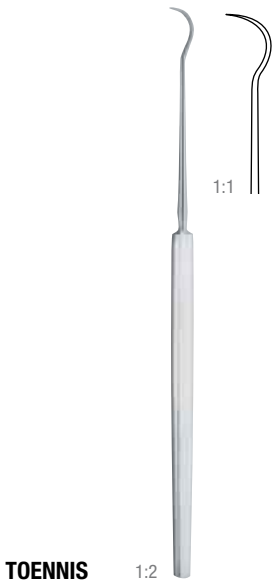

TOENNIS 1:2
150 mm – 6"
424-825-150



DANDY 1:2 1:2 1:2
200 mm – 8" 340-048-200 340-047-200 340-049-200



ADSON 1:2 1:1 1:1
200 mm – 8" 24-449-200 24-451-200



Nervenhaken – Durahaken

Nerve hooks – Dura hooks

Crochets à nerfs – Crochets pour duremère
 Ganchos para nervios – Ganchos para duramadre
 Uncini per nervi – Uncini per duramadre



LOVE

190 mm – 7 1/2"	24-491-000	24-491-045	24-491-090
-----------------	------------	------------	------------

YASARGIL

310 mm – 12 1/4"	424-674-010
410 mm – 16 1/4"	424-674-020

Galeahaken
 Galea retractor
 Retracteur Galea
 Retractor de Galea
 Rettrotore di Galea

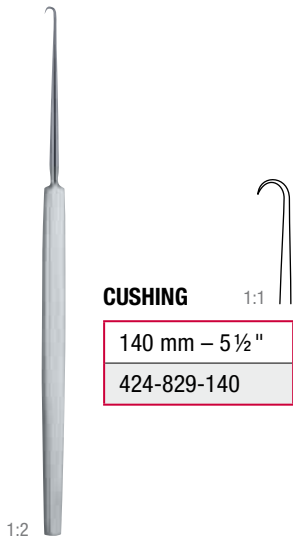

CUSHING

140 mm – 5 1/2"
424-829-140

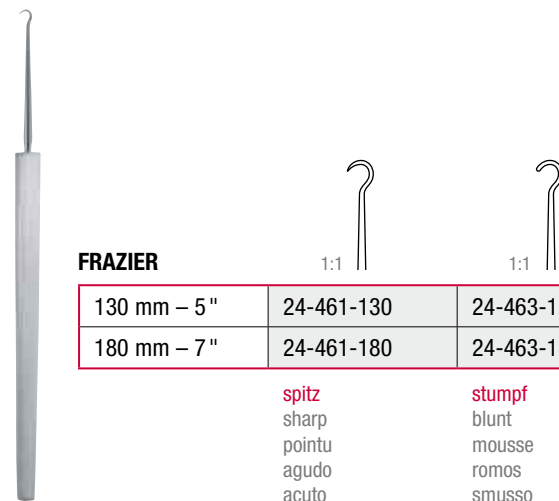

FRAZIER

130 mm – 5"	24-461-130	24-463-130
180 mm – 7"	24-461-180	24-463-180

spitz
 sharp
 pointu
 agudo
 acuto

stumpf
 blunt
 mousse
 romos
 smusso

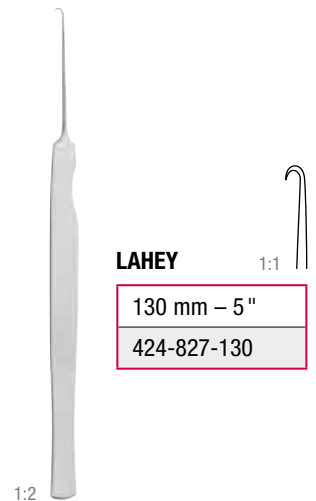

LAHEY

130 mm – 5"
424-827-130

Dura-Dissektoren

Dura dissectors

Décolleurs duremère

Disectores de duramadre

Dissetori per duramadre

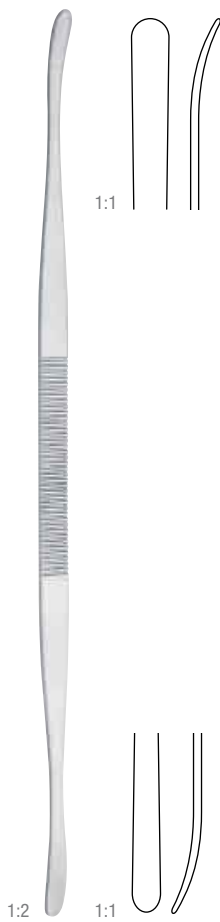

TOENNIS

1:2 1:1

250 mm – 9¾"

340-137-250



DAVIS

1:2 1:1

245 mm – 9¾"

27-901-245

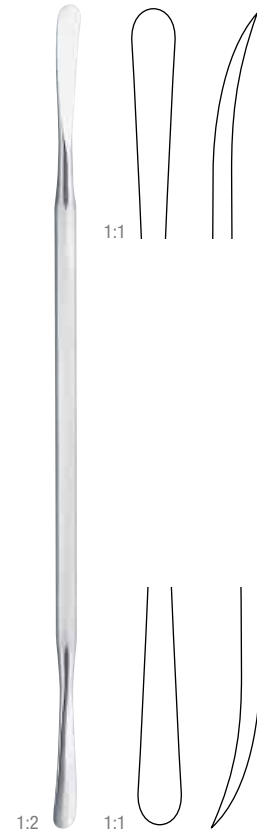

1:2 1:1

220 mm – 8¾"

340-145-220



Dura-Dissektoren
Dura dissectors

Décolleurs duremère
Disectores de duramadre
Dissetori per duramadre

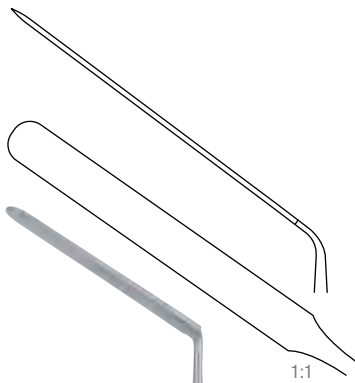

1:1



1:2

HORSLEY

200 mm – 8"

340-151-200

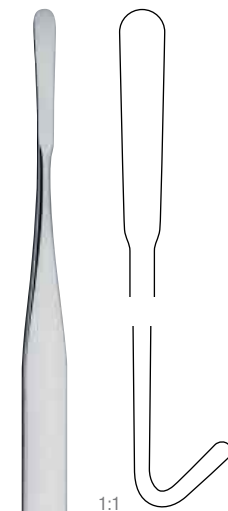

1:1



1:2

SMITHWICK

290 mm – 11 ½"

340-066-290

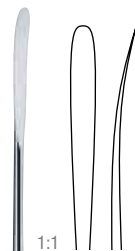

1:1



1:2

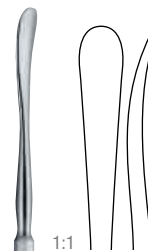

1:1



1:2



1:1



1:2

SACHS

210 mm – 8 ¼"

340-141-210

340-139-210

27-941-210

Dura-Dissektoren
Dura dissectors

Décolleurs duremère
Disectores de duramadre
Dissetori per duramadre

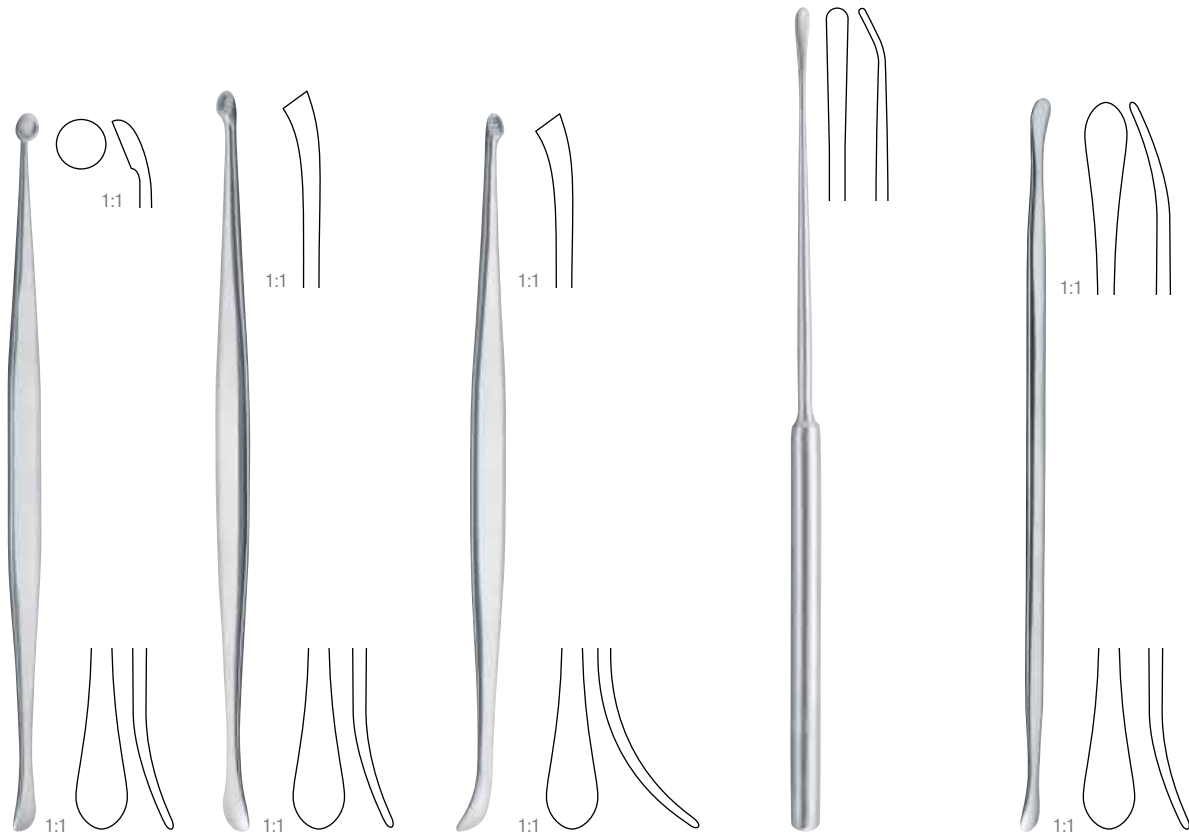

PENFIELD

Fig. 1	Fig. 2	Fig. 3	Fig. 4	Fig. 5
175 mm – 7"	195 mm – 7¾"	195 mm – 7¾"	215 mm – 8½"	185 mm – 7¼"
340-157-010	340-157-020	340-157-030	340-157-040	340-157-050



Neuro-Mikro-Dissektoren

Neuro-micro dissectors

Neuro-micro dissecteurs
Disectores para micro-neurocirugía
Strumento per micro-neuro chirurgia



YASARGIL

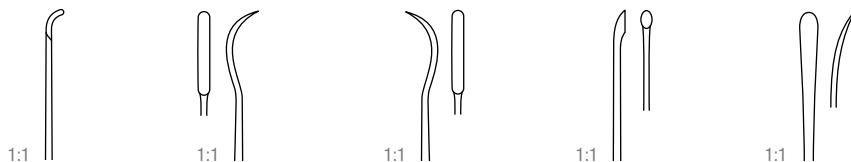

190 mm – 7 ½ "	424-946-070	424-946-080	424-946-090	424-946-100	424-946-050
----------------	-------------	-------------	-------------	-------------	-------------

gerade
straight
droit
recta
rette

190 mm – 7 ½ "	424-953-050	424-953-030	424-953-040	424-955-190	424-953-020
----------------	-------------	-------------	-------------	-------------	-------------

bajonett
bayonet
baionette
bayoneta
baionetta

YASARGIL

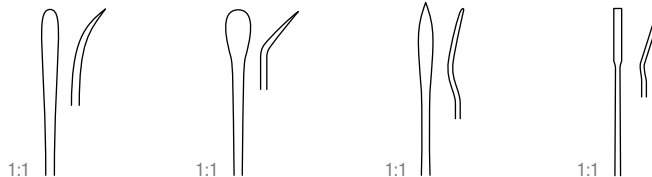

190 mm – 7 ½ "	424-946-060	424-946-040	424-946-030	424-946-010
----------------	-------------	-------------	-------------	-------------

gerade
straight
droit
recta
retta

190 mm – 7 ½ "	424-947-010	424-947-020	424-947-030	424-947-040
----------------	-------------	-------------	-------------	-------------

bajonett
bayonet
baionette
bayoneta
baionetta

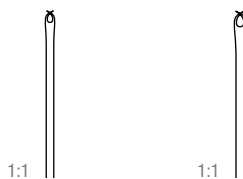

190 mm – 7 ½ "	340-186-100	340-186-180
----------------	-------------	-------------

gerade, mit Dreh-Fixierhaken
straight, with Twist-fixationhook
droit, avec crochet de fixation
recta, con gancho de fijación
rette, con uncino di fissaggio „Twist“

Neuro-Mikro-Dissektoren
Neuro-micro dissectors

Neuro-micro dissecteurs
Disectores para micro-neurocirugía
Strumento per micro-neuro chirurgia



1:1

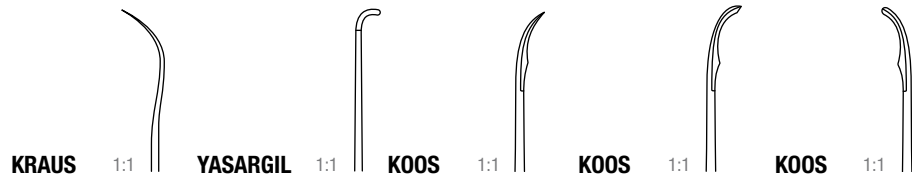

190 mm – 7 ½"	KRAUS 1:1 424-917-190	YASARGIL 1:1 424-919-190	KOOS 1:1 424-909-190	KOOS 1:1 424-911-190	KOOS 1:1 424-913-190
---------------	---------------------------------	------------------------------------	--------------------------------	--------------------------------	--------------------------------

bajonett
bayonet
baionette
bayoneta
baionetta



Neuro-Mikro-Dissektoren

Neuro-micro dissectors

Neuro-micro dissecteurs
 Disectores para micro-neurocirugía
 Strumento per micro-neuro chirurgia

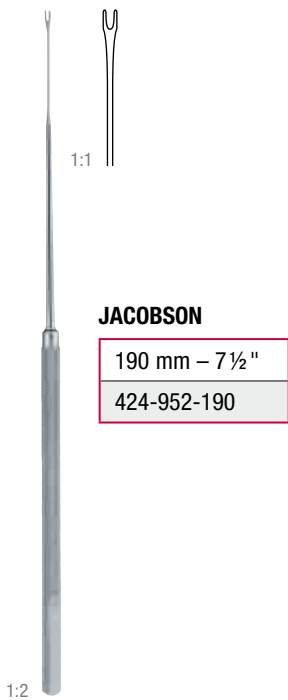

JACOBSON

190 mm – 7 ½"
424-952-190

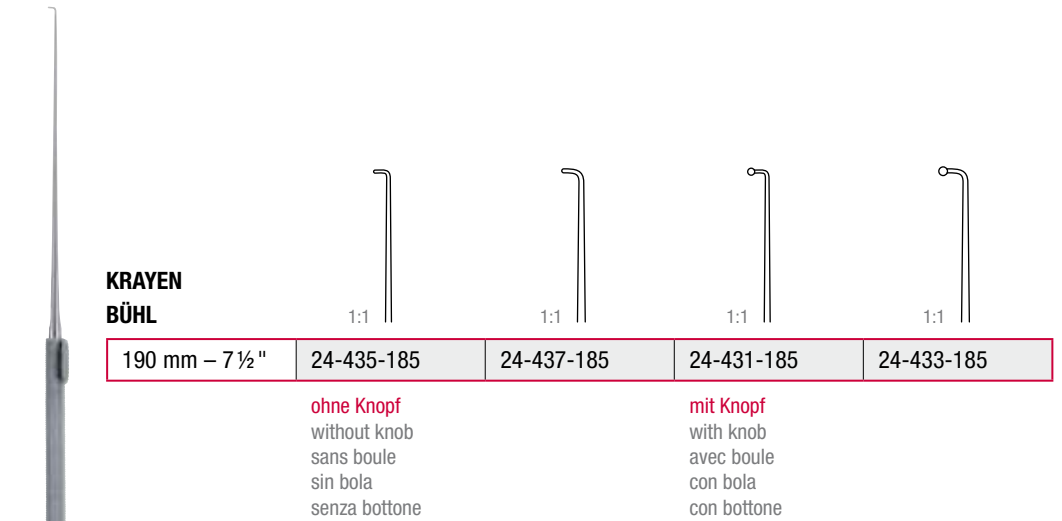

**KRAYEN
 BÜHL**

190 mm – 7 ½"	24-435-185	24-437-185	24-431-185	24-433-185
---------------	------------	------------	------------	------------

ohne Knopf
 without knob
 sans boule
 sin bola
 senza bottone

mit Knopf
 with knob
 avec boule
 con bola
 con bottone

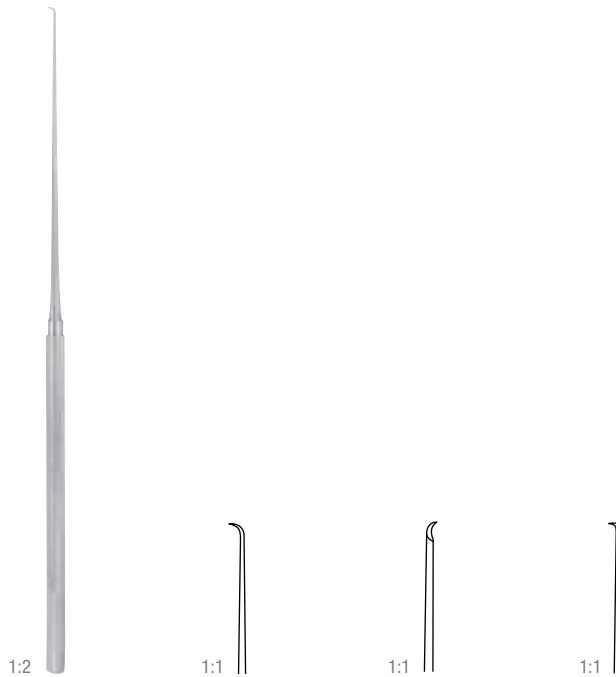

JACOBSON

FISCH

190 mm – 7 ½"	340-187-010	424-906-190	340-187-020
---------------	-------------	-------------	-------------

Neuro-Dissektoren und Küretten
Neuro dissectors and curettes

Neuro-dissecteurs et curettes
Disectores y curetas para neurocirugía
Scollatori per neuro-chirurgia



HARDY

250 mm – 9¾"	340-828-020	340-827-020	340-827-030	340-828-010
--------------	-------------	-------------	-------------	-------------

bajonett, innen scharf
bayonet, sharp inner edge
baionette, tranchant à l'interno
bayoneta, cortante al interno
baionetta, acuto all'interno

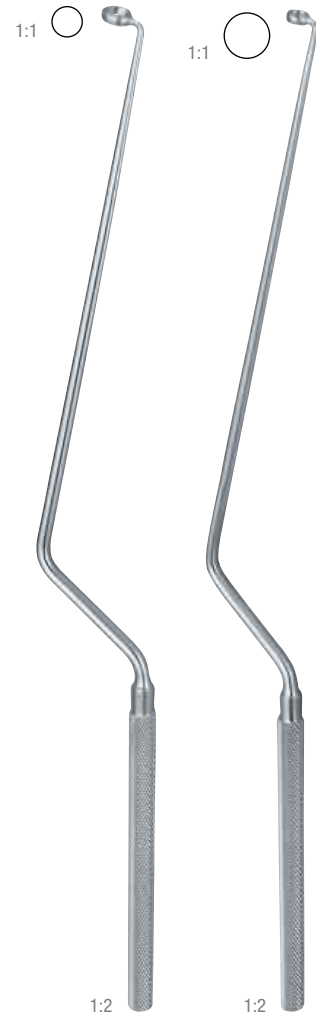

HARDY

	4 mm Ø	6 mm Ø
270 mm – 10¾"	340-811-040	340-811-060

bajonett, biegsam
bayonet, malleable
baionette, malléable
bayoneta, maleable
baionetta, flessibile